

idOil[®]-30

idOil[®]-30 3G

Oil Separator Alarm Device



Table of contents

1. General information about the manual	4
1.1. Markings and symbols	4
1.2. Conformity of the product	4
1.3. Limitation of liability	4
2. Safety and the environment	5
2.1. General safety instructions	5
2.2. Intended use	5
2.3. Transport and storage	5
2.4. Installation and commissioning	5
2.5. Repair	6
2.6. Decommissioning and disposal	6
3. Product description	7
3.1. Device operation	7
3.2. Products	8
3.3. Dimensions	9
3.3.1. Dimensions of the idOil control unit	9
3.3.2. Dimensions idOil-LIQ high liquid level sensor	9
3.3.3. Dimensions of the idOil-OIL oil sensor	10
3.3.4. Dimensions idOil-SLU sludge sensor	10
4. Installation	11
4.1. Installing the control unit	11
4.2. Sensor installation	11
4.2.1. Installing the idOil-LIQ high liquid level sensor	12
4.2.2. Installing the idOil-OIL sensor	12
4.2.3. Installing the idOil-SLU sludge sensor	13
5. Connections	14
5.1. Connection diagrams	14
5.1.1. Connection with a single-sensor cable connector	14
5.1.2. Connection with a two-sensor cable connector	15
5.1.3. Connection with a three-sensor cable connector	15
5.2. Explanations of connection diagrams	16
6. Commissioning	17
6.1. Simple commissioning	17
6.2. Factory settings of the idOil control unit	19
6.3. Commissioning through the browser-based user interface	20
6.3.1. Establishing a WLAN connection	20
6.3.2. System settings	21
6.3.3. Sensor naming and identification	22
7. Operation	25
7.1. Local display and alarms	25
7.2. Resetting an alarm	26
7.3. Using the browser-based user interface	26

7.3.1. Home screen	27
7.3.2. Menu list	28
7.3.2.1. Alarm log	29
7.3.2.2. Inspection	30
7.3.2.3. Inspection log	31
7.3.2.4. Language	32
7.3.2.5. Date and time	33
7.3.3. Settings menu	33
7.3.3.1. Customer data	34
7.3.3.2. Inspection settings	35
7.3.3.3. Alarm settings	36
7.3.3.4. Relay settings	36
7.3.3.5. Software update	38
7.3.3.6. Restoring factory settings	39
7.3.3.7. WLAN settings	40
7.3.3.8. 3G settings (idOil-30 3G model only, option)	41
8. Maintenance	43
8.1. Functional test	43
8.1.1. Test function	43
8.1.2. Functional test with sensors	44
8.2. Maintenance measures	44
8.3. Troubleshooting	45
9. Technical specifications	46
9.1. Technical specifications for the idOil control unit	46
9.2. Technical specifications idOil-LIQ high liquid level sensor	47
9.3. Technical specifications idOil-OIL oil sensor	48
9.4. Technical specifications idOil-SLU sludge sensor	48
10. Appendices	50
10.1. APPENDIX A System digram	50
10.2. APPENDIX B EU Declaration of Conformity	53

1. General information about the manual

This manual is an integral part of the product.

- Please read the manual before using the product.
- Keep the manual available for the entire duration of the product's life span.
- Provide the manual to the next owner or user of the product.
- Please report any errors or discrepancies related to this manual before commissioning the device.

1.1. Markings and symbols

Safety-related markings and symbols



This marking warns of a possible hazard. Failing to observe the safety instructions in question may result in injury or death.



This marking warns of a fault or hazardous situation. Failing to observe the safety instructions in question may result in injury or device breakage.



This marking warns of a possible fault. Failing to observe the safety instructions in question may result in device or system breakage or erroneous operation.



This marking emphasises an issue that requires special attention during installation and when using the device in an explosive atmosphere.

Informative markings and symbols



This marking highlights essential information.



This marking refers to a user measure.

1.2. Conformity of the product

The EU declaration of conformity and the product's technical specifications are integral parts of this document.

All of our products have been designed and manufactured with due consideration to the essential European standards, statutes and regulations.

Labkotec Oy has a certified ISO 9001 quality management system and ISO 14001 environmental management system.

1.3. Limitation of liability

Due to continuous product development, we reserve the right to change these operating instructions.

The manufacturer cannot be held liable for direct or indirect damage caused by neglecting the instructions provided in this manual or directives, standards, laws and regulations regarding the installation location.

The copyrights to this manual are owned by Labkotec Oy.

2. Safety and the environment

2.1. General safety instructions

The plant owner is responsible for the planning, installation, commissioning, operation, maintenance and disassembly at the location.

Installation and commissioning of the device may be performed by a trained professional only.

Protection of operating personnel and the system is not ensured if the product is not used in accordance with its intended purpose.

Laws and regulations applicable to the usage or the intended purpose must be observed. The device has been approved for the intended purpose of use only. Neglecting these instructions will void any warranty and absolve the manufacturer from any liability.

2.2. Intended use

The idOil alarm system is intended for monitoring liquid levels particularly in oil and sand separators.

The system consists of a control unit and connected sensors that have been installed in the oil or sand separator. The sensors can be placed in a zone 0 explosive atmosphere, but the control unit must be positioned in a safe area.

A more specific description of the product's operation, installation and use is provided later in this manual.

The device must be used in accordance with the instructions provided in this document. Other use is counter to the product's purpose of use. Labkotec cannot be held liable for any damage caused by using the device in violation of its purpose of use.

2.3. Transport and storage

Check the packaging and its content for any possible damage.

Ensure that you have received all the ordered products and that they are as intended.

Keep the original package. Always store and transport the device in the original packaging.

Store the device in a clean and dry space. Observe the permitted storage temperatures. If the storage temperatures have not been presented separately, the products must be stored in conditions that are within the operating temperature range.

2.4. Installation and commissioning













The device does not have a mains switch and therefore the supply voltage wires near the device should be fitted with an isolating switch (250 VAC/12 VA), which disconnects the wires (L1, N), in order to facilitate service and repair procedures. The switch must be labelled as the unit's isolating switch. The external switch must adhere to the standard IEC/EN 60947-1 or IEC/EN 60947-3.

UL/CSA: Supply cable 3 x 1,5-2,1 mm² (AWG16-AWG14). Supply voltage max fuse size 10 A.

Other areas: Supply cable 3 x 1,5-2,5 mm² (AWG16-AWG13). Supply voltage max fuse size 16 A.

The supply voltage and local supply voltage tolerances must be taken into account with regard to the cable's maximum voltage.

-  If the temperature in the installation environment is expected to exceed +40°C, the temperature tolerance of the supply voltage and relay connection cable must be at least +80°C. Otherwise, any cable that meets the applicable electrical regulations can be used as the supply voltage and relay connection cable.
-  Due to the overvoltage protection, the protective earth wire (PE) must be connected to the supply voltage connector (see Section Connections).
-  The internal temperature of the device can be 10°C higher than the ambient temperature. This must be taken into account in the cabling of the device.
-  The voltage connected to the contacts of both relays must be in the same voltage class (ELV/LV), considering the maximum values listed in the technical specifications.
-   The idOil control unit must not be installed in potentially explosive areas, but a sensor connected to it may be installed in potentially explosive atmospheres of zones 0, 1 and 2. In potentially explosive area installations, the national regulations and appropriate standards IEC/EN 60079-25 Intrinsically safe electrical systems "i" and/or IEC/EN 60079-14 Explosive atmospheres - Electrical installations design, selection and erection must all be followed.
-   If it is possible that static electricity can cause hazards in the measurement environment, equipotential bonding must be attended according to the regulations concerning potentially explosive atmospheres. Equipotential bonding is done by connecting all conductive parts to the same potential e.g. in a junction box. Equipotential bonding system must be grounded.
-   The instructions concerning the inspection and maintenance of Ex equipment contained in the standards IEC/EN 60079-17 and IEC/EN 60079-19 should be observed when executing service, inspection or repair procedures in potentially explosive atmospheres.
-  See Technical specifications; Connection values and Appendix A System diagram.

2.5. Repair

The device may not be repaired or modified without the manufacturer's permission. If the device exhibits a fault, it must be delivered to the manufacturer and replaced with a new device or one repaired by the manufacturer.

2.6. Decommissioning and disposal

The device must be decommissioned and disposed of in compliance with local laws and regulations.

3. Product description

3.1. Device operation

idOil® is an alarm system intended for monitoring liquid levels particularly in oil and sand separators. The system consists of the idOil control unit and the idOil sensors installed in the separator. The sensor cables can be extended with a cable connector or connection box.

One to three digital idOil sensors of the same or different type can be connected to the control unit. The sensors can be used to monitor the following:

- High liquid level (idOil-LIQ high liquid level sensor)
- Oil layer detection (idOil-OIL oil sensor)
- Sludge layer detection (idOil-SLU sludge sensor)

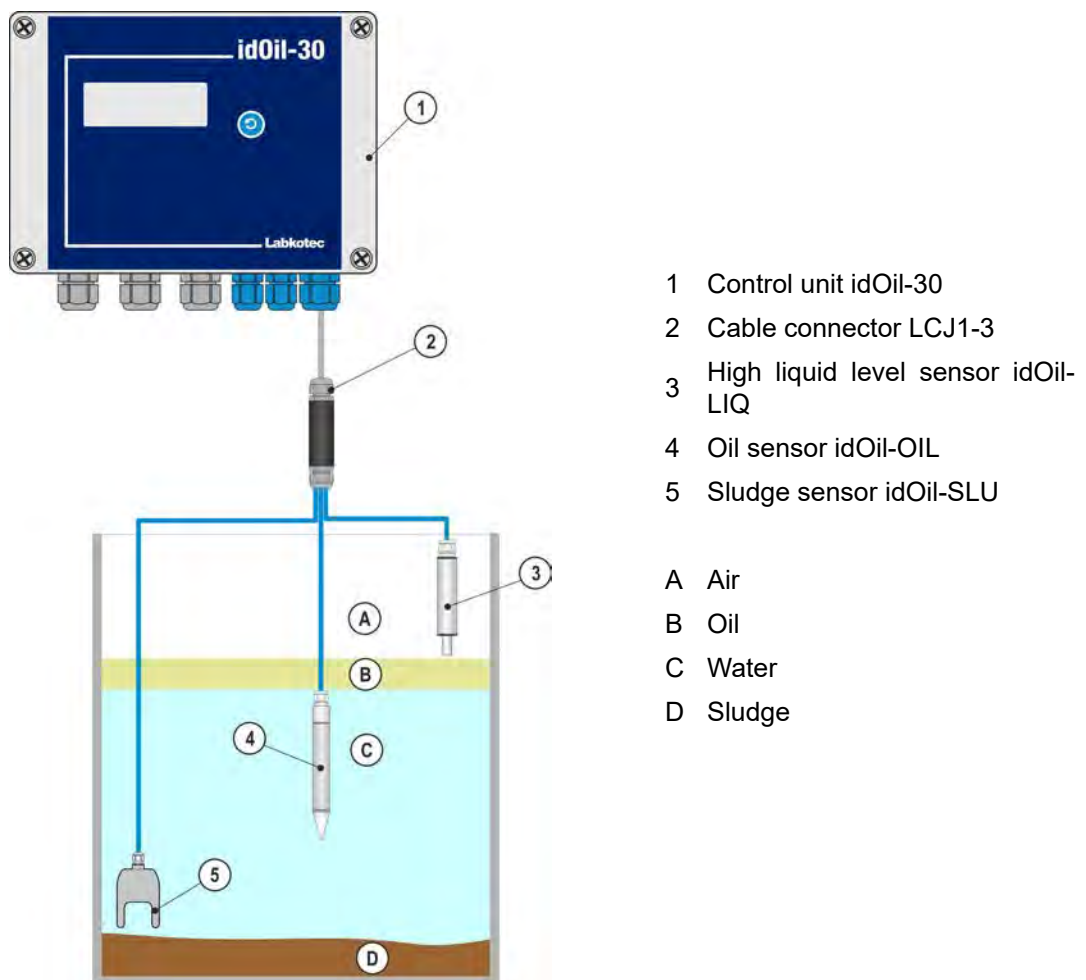

Figure 1. System description; idOil control unit, sensors and cable extension

The system state, alarms and failures are shown on the control unit display.

In alarm and fault situations, the buzzer sounds an alarm and the relays are switched to the alarm position.

The relays are of the failsafe type, which means that they also enter the alarm state when operating power is lost.

The system settings can be changed with the device's browser-based operating system via a WLAN connection.

The idOil alarm system can also be delivered with a 3G data transfer module and antenna. The idOil alarm system with the 3G module (idOil-30 3G) sends alarms and timed measurements either directly to the user's phone as SMS messages or to the LabkoNet® server, from which the information can be distributed to other parties that need it. You can modify the settings with your phone or through the browser-based operating system of the device. The SMS commands of the 3G module are described in document DOC001696.

The operation of the product is described in more detail in the section Operation.

3.2. Products

Control unit:

Type name	Description
idOil-30	Control unit, 100-240 V AC
idOil-30 3G	Control unit, 100-240 V AC with 3G module

Sensors:

Type name	Description
idOil-LIQ	High liquid level sensor to sense excessively high liquid level
idOil-OIL	Oil sensor to detect the thickness of the oil layer
idOil-SLU	Sludge sensor to detect the thickness of the sludge layer

Accessories:

Type name	Description
LCJ1-1	Cable connector for one sensor
LCJ1-2	Cable connector for two sensors
LCJ1-3	Cable connector for three sensors
LMS-SAS2	Mounting kit for control unit
LMS-SAS5	Mounting kit for sensor

3.3. Dimensions

3.3.1. Dimensions of the idOil control unit

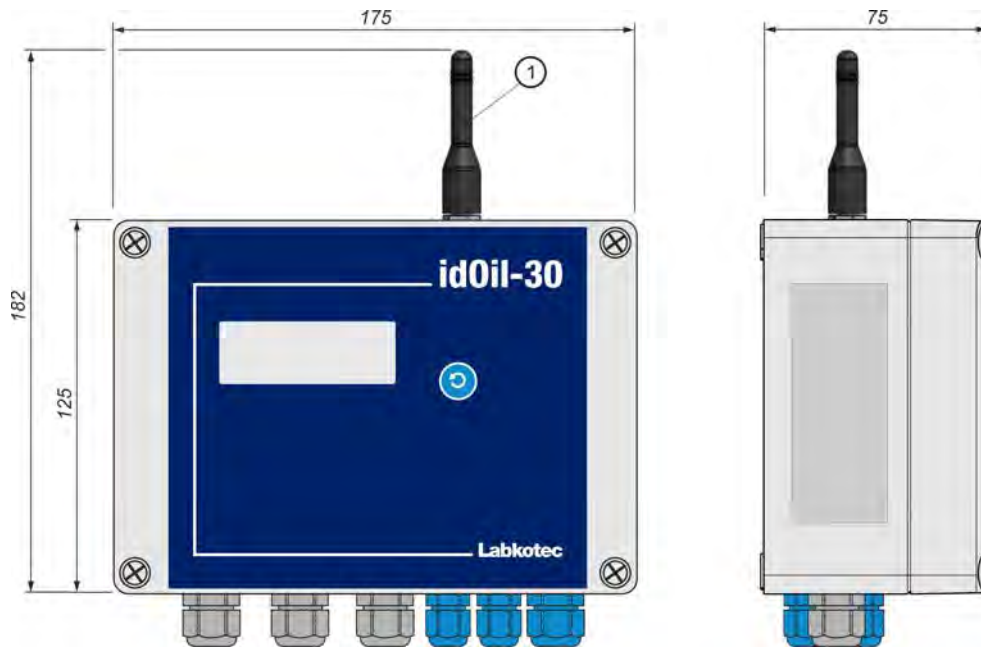

1 idOil-30 3G model with antenna (option)

Figure 2. Dimensions of the idOil control unit (mm)

3.3.2. Dimensions idOil-LIQ high liquid level sensor

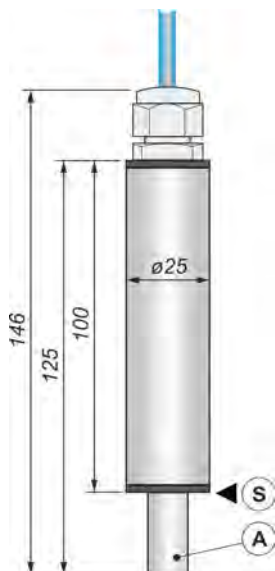

- A Sensor's sensing element
- S Alarm switching point

Figure 3. High liquid level sensor idOil-LIQ – structure and dimensions (mm)

3.3.3. Dimensions of the idOil-OIL oil sensor

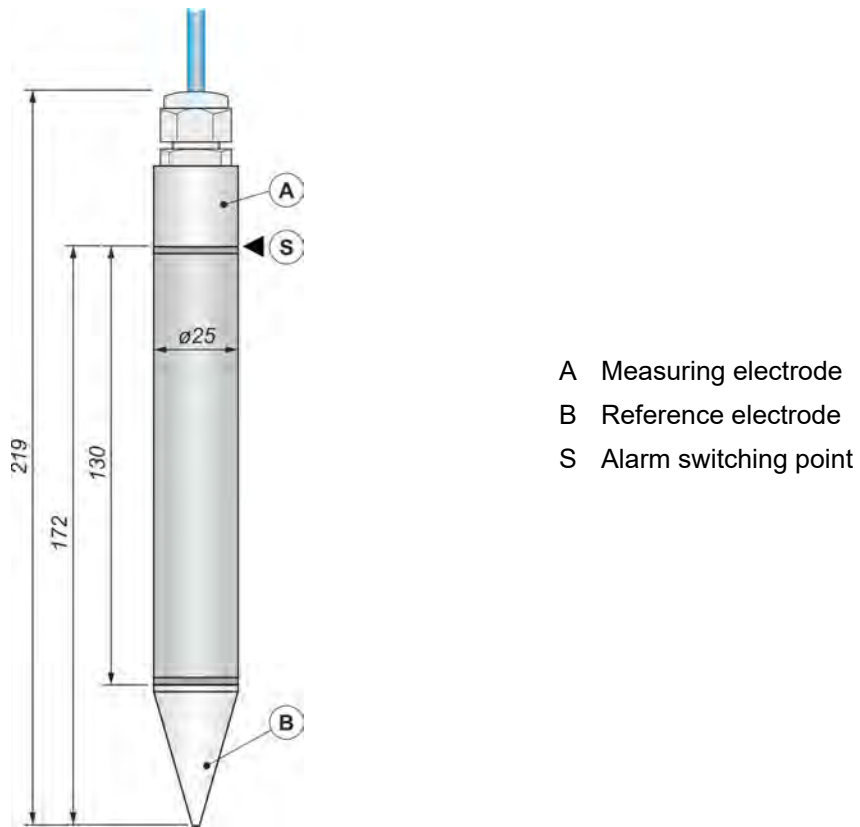

Figure 4. Oil sensor idOil-OIL – structure and dimensions (mm)

3.3.4. Dimensions idOil-SLU sludge sensor

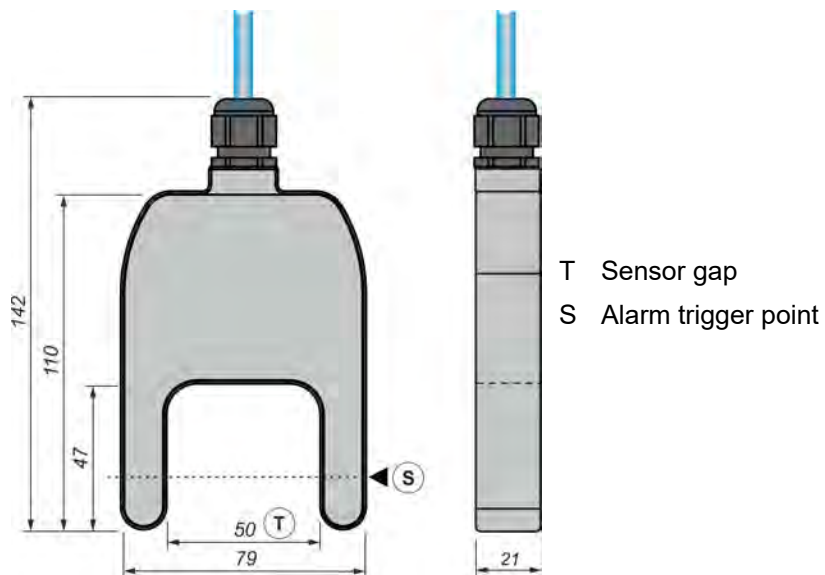

Figure 5. Sludge sensor idOil-SLU – structure and dimensions (mm)

4. Installation

4.1. Installing the control unit

The idOil control unit is wall mounted. Installation holes are located at the bottom part of the box under the mounting holes for the cover.

The cover of the box must be tightened so that the edge touches the bottom part. This ensures that the reset and test button functions well and the enclosure is tight.



The control unit must be installed in a safe (non-Ex) space.



Read Section General safety instructions before installation.

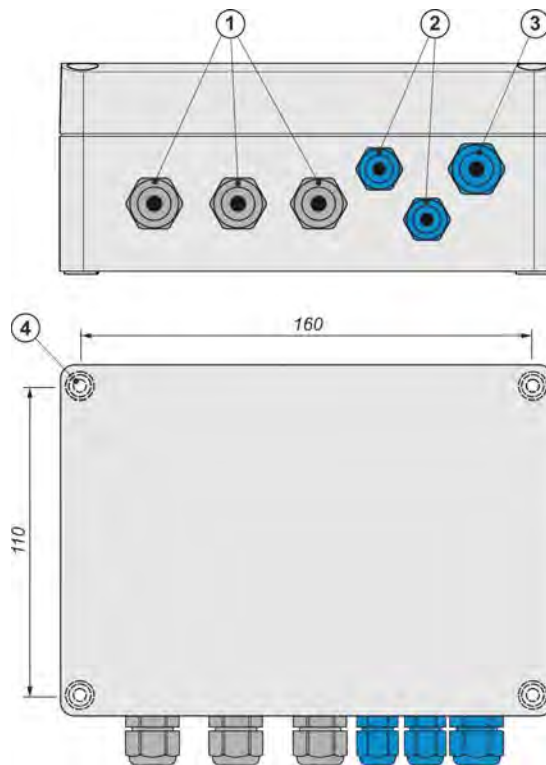

- 1 Cable glands M16 grey, 3 pcs
 - 2 Cable glands M12 blue, 2 pcs
 - 3 Cable glands M16 blue, 1 pc
 - 4 Fastening holes $\varnothing 4.5$ mm, 4 pcs
- Installation dimensions 160 x 110 mm

Figure 6. Installing the idOil control unit

4.2. Sensor installation



idOil sensors can be installed in zone 0 explosive atmospheres. Do not remove the sensor markings from the cables or sensor frames.



Read Section General safety instructions before installation.



Check the correct installation depth of the sensor in the instructions of the separator in question.

For example, sensors can be installed suspended from their cable (see next figure). Leave a sufficient length of the sensor or extension cable coiled inside the service well, so that you can easily lift the sensor out for inspection and cleaning.

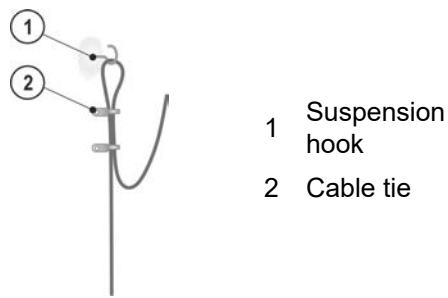

Figure 7. Sensor suspension example



Figure 8. Sensor mounting supplies LMS-SAS5

4.2.1. Installing the idOil-LIQ high liquid level sensor

The sensor is normally in air, and it issues an alarm when the sensing element is submerged in liquid. The sensor is installed at a suitable height above the standard liquid level (L) so that the overflow alarm is activated once the liquid level reaches the sensing element.

Overflow is possible in the following cases, for example:

- if the filter is dirty
- if the automatic closure device is blocked
- or if some other situation causes blockage in the discharge pipe

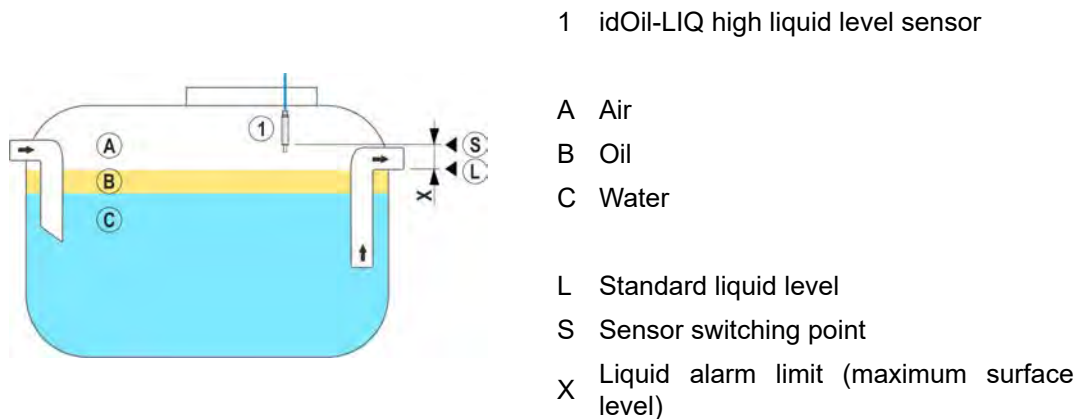

Figure 9. Installing the idOil-LIQ high liquid limit sensor

4.2.2. Installing the idOil-OIL sensor

The sensor must be submerged at the desired installation depth when the liquid is at the separator’s standard liquid level (L).

The exact installation depth depends on the following:

- separator type
- separator shape
- volume and height of the separator’s oil compartment

The sensor must always be immersed in liquid. The alarm is activated when the lower surface of the oil layer reaches the alarm switching point (S), i.e. when the sensor’s measuring electrode is covered in oil.

i The sensor activates the alarm when it is in contact with air. For this reason, the separator must always be filled with water after draining.

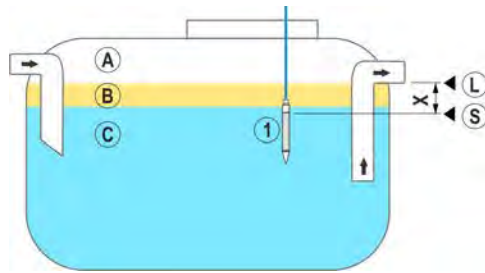

1 idOil-OIL oil sensor

A Air
B Oil
C Water

L Standard liquid level
S Alarm switching point
X Maximum allowed oil layer thickness

Figure 10. Installing the idOil-OIL sensor

4.2.3. Installing the idOil-SLU sludge sensor

The sensor issues an alarm on sludge, sand or other solids accumulated at the bottom of the separator.

The sensor's exact installation depth depends on the following:

- separator type
- separator shape
- maximum allowed sludge layer thickness

The sensor must always be immersed in liquid. The alarm is activated when the sludge layer reaches the alarm switching point (S), which is located inside the sensor gap (T).

i The sensor activates the alarm when it is in contact with air. For this reason, the separator must always be filled with water after draining.

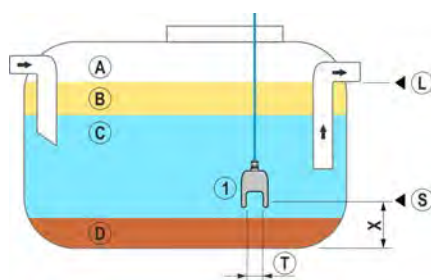



1 idOil-SLU sludge sensor

A Air
B Oil
C Water
D Sludge

L Standard liquid level
S Alarm switching point
X Maximum allowed sludge layer height
T Sensor gap

Figure 11. Installing the idOil-SLU sludge sensor

5. Connections

-  Read Section General safety instructions before installation.
-  Make the connections when the device is de-energised.
-  The legends for the connection diagrams can be found in the section following the diagrams.

5.1. Connection diagrams

5.1.1. Connection with a single-sensor cable connector

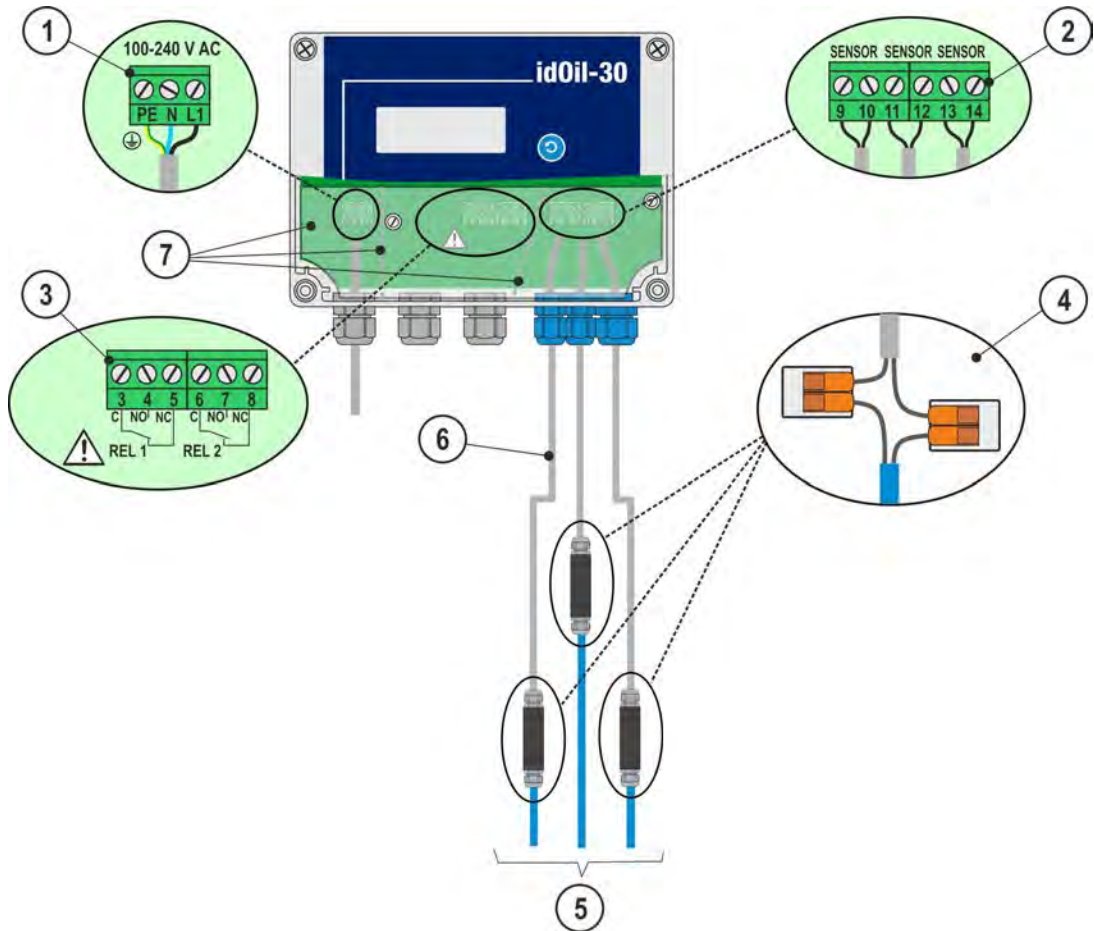

Figure 12. Connection with a single-sensor cable connector

5.1.2. Connection with a two-sensor cable connector

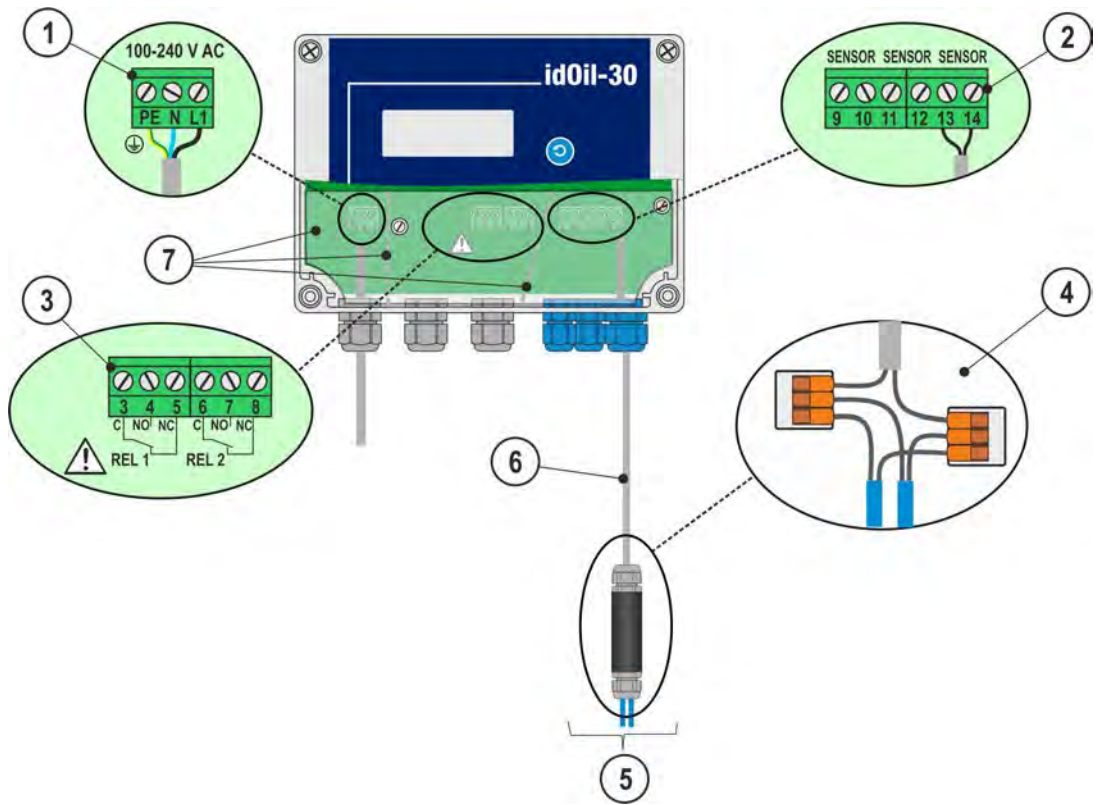

Figure 13. Connection with a two-sensor cable connector

5.1.3. Connection with a three-sensor cable connector

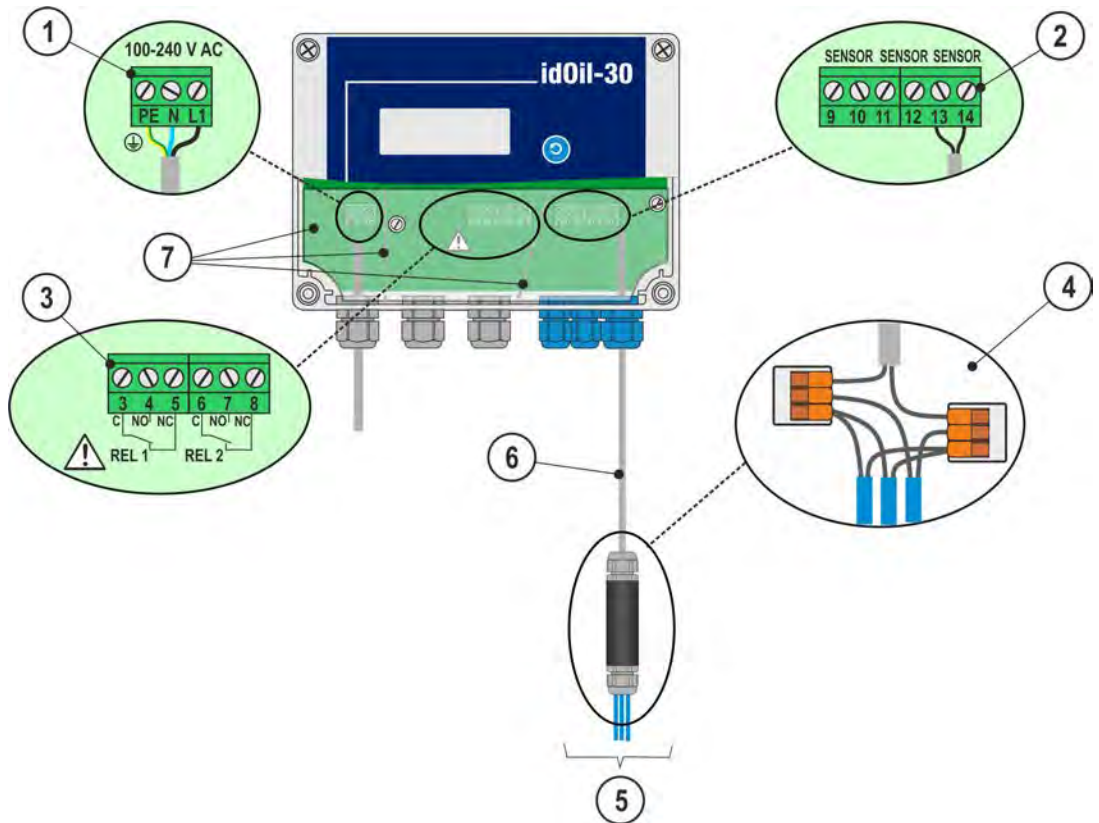

Figure 14. Connection with a three-sensor cable connector

5.2. Explanations of connection diagrams

- 1 Supply voltage 100–240 V AC
(N.B. The device does not include a mains switch, see Section General safety instructions)

PE = protective earth connector

N = neutral connector

L1 = phase connector

UL/CSA: Supply cable 3 x 1,5-2,1 mm² (AWG16-AWG14). Supply voltage max fuse size 10 A.



Other areas: Supply cable 3 x 1,5-2,5 mm² (AWG16-AWG13). Supply voltage max fuse size 16 A.

The supply voltage and local supply voltage tolerances must be taken into account with regard to the cable's maximum voltage.

- 2 Sensor connectors

9 = sensor 1, connection 1

10 = sensor 1, connection 2

11 = sensor 2, connection 1

12 = sensor 2, connection 2

13 = sensor 3, connection 1

14 = sensor 3, connection 2



The sensor connection is a polarity-free digital bus, which means that it does not matter which sensor terminal the wires are connected to.

- 3 Relay outputs

RELAY 1

3 = Relay common contact

4 = Contact that opens in an alarm situation

5 = Contact that closes in an alarm situation

RELAY 2

6 = Relay common contact

7 = Contact that opens in an alarm situation

8 = Contact that closes in an alarm situation



The maximum values presented in the technical specifications must be taken into account.

- 4 Cable connector:

LCJ1-1 for a single sensor

LCJ1-1 for two sensors

LCJ1-3 for three sensors

- 5 Sensors

- 6 Extension cable, e.g. protected, twisted-pair 2 x 0.5 mm², maximum resistance 68 Ohm.

Extra wires and shield must be cut and isolated carefully.

- 7 Protection plate



The connectors for the external connections are separated with separator walls on the protection plate. The separator walls must not be removed. The protection plate covering the connectors must be reinstalled after connecting the cables.

6. Commissioning

The device can be commissioned in the two ways described in the following sections:

- Simple commissioning
- Commissioning through the browser-based user interface

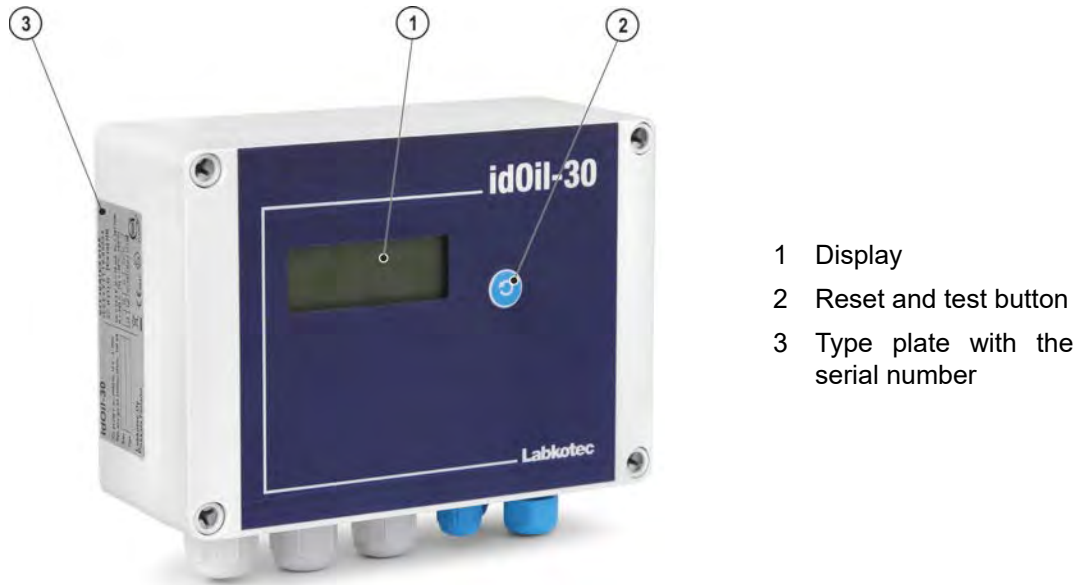

- 1 Display
- 2 Reset and test button
- 3 Type plate with the serial number

Figure 15. User interface description

6.1. Simple commissioning

Ensure that the sensors have been installed and connected in the control unit in accordance with the instructions in the previous paragraphs.

- ▶ Connect power to the control unit.

A message is shown in the control unit display: NO SENSORS.

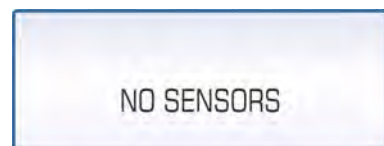

Figure 16. Initial start-up

- ▶ Open the cover of the control unit.



DANGER OF ELECTRICAL SHOCK! Do not remove the connector protection plate and avoid touching energised parts.

- ▶ Briefly press the sensor identification button (1).

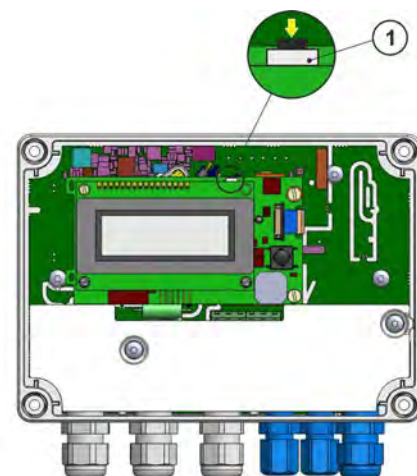

Figure 17. Sensor identification button.

The control unit display shows the message "Detecting sensors, 0 sensor(s) found" and three dots begin cycling at the bottom of the display.

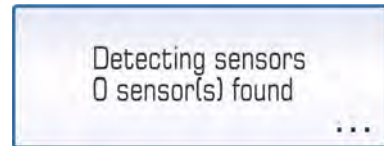

Figure 18. Sensor identification.

Depending on how many sensors are connected to the control unit, the display may show the following message, for example: "Detecting sensors, 3 sensor(s) found".



Figure 19. Three sensors found.

Once all sensors have been identified, the display shows the message: SYSTEM OK.

► Close the cover of the enclosure.

The idOil separator alarm system is now operational at factory settings.

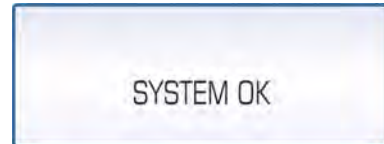

Figure 20. All sensors found.

If the control unit does not identify all connected sensors.

► Check the sensor connections.

► After the check, press the sensor identification button again.



The control unit will look for the sensors for approx. 2 minutes, unless it has already found three sensors.

The sensor identification can be stopped by pressing the sensor identification button for 5 seconds.

SIM card installation (idOil-30 3G model only, option).



DANGER OF ELECTRICAL SHOCK! Do not remove the connector protection plate and avoid touching energised parts.

- ▶ Ensure that the device is de-energised.
- ▶ Open the cover of the control unit and ensure that the connection protection plate is in place!
- ▶ Pull the SIM-holder (2) out from 3G module and install nano-SIM (1) to holder.
- ▶ Push the holder back to 3G module as shown in figure.
- ▶ Close the cover and connect power to the control unit.

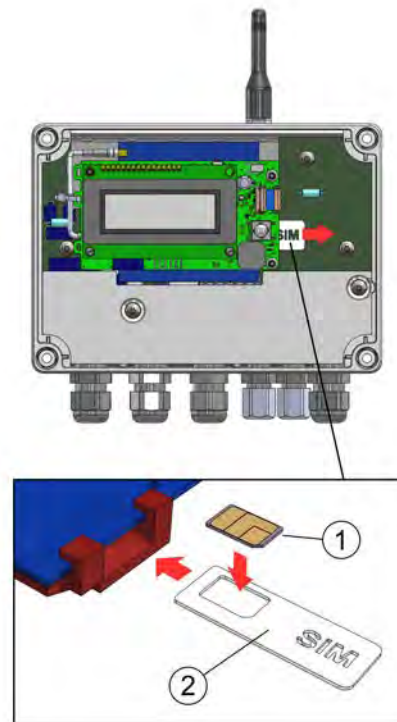

Figure 21. SIM card installation

When the control unit is searching network, there is signal strength bar with X symbol in the upper right corner of the local display.

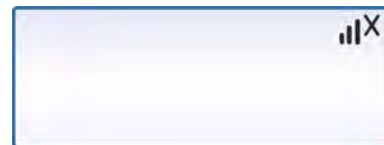

Figure 22 . Device is searching network

When the control unit is found the network, the X symbol disappears and the signal strength bar is left in the upper corner of the local display.

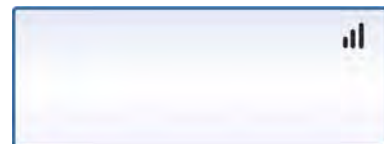

Figure 23 . Device is connected in network

6.2. Factory settings of the idOil control unit

System settings	Language	English
	Date and time	not set
Alarm settings	Alarm buzzer	on
	Alarm repeat (24h)	on
	Alarm delay for all sensors	10 s
	Alarm reset button	on
Inspection settings	Inspection interval counter and inspection warning	not set

Relay settings	Relay 1	Connected sensors	All sensors connected to the control unit
		function	function upon sensor alarm and sensor fault
		maintenance period alarm	off
		relay is restored when alarm is reset	no
	Relay 2	Connected sensors	All sensors connected to the control unit
		function	function upon sensor alarm and sensor fault
		maintenance period alarm	off
		relay is restored when alarm is reset	no
M2M Settings	SMS reporting		Enable reporting: No
	LabkoNet		Enable LabkoNet Service: Off

Restoring factory settings is described in Section Settings.

6.3. Commissioning through the browser-based user interface

The commissioning process can also be performed through the control unit's built-in browser-based user interface. For this, you must establish a local WLAN connection between the idOil control unit and a terminal device, such as a smartphone, PC or tablet.

More details on using the browser-based interface is provided in the section Using the browser-based interface.

6.3.1. Establishing a WLAN connection

- ▶ Connect power to the idOil control unit.

The display presents the message shown in the figure: NO SENSORS.

- ▶ Press the reset button briefly.

A symbol indicating a WLAN network connection is shown in the upper left corner of the display.

If the device power is already on, press the reset button twice; the first push activates the backlight and the second press activates the WLAN connection.

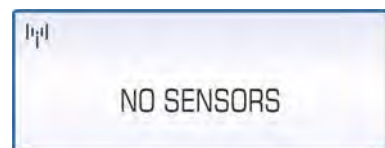

Figure 24. WLAN network on

- ▶ Establish a WLAN connection between the idOil control unit and terminal device as follows:

1. Use the network settings of the terminal device to find the WLAN network provided by the idOil device.
2. Enter the WLAN network password. The password is five zeroes followed by the eight final characters of the device's serial number. The serial number can be found in the idOil device's type plate.
If the serial number is 8540564_1112118J, for example, the WLAN password is 000001112118J.
3. Open the web browser of your terminal device and enter the IP address: 192.168.0.1.

A connection has now been formed between the terminal device and the idOil control unit.

The WLAN network will remain active for 10 minutes after terminal devices are no longer connected to it.

The following sections detail the measures required in connection to initial use.

6.3.2. System settings

The System settings view shown in the figure is opened in the browser.

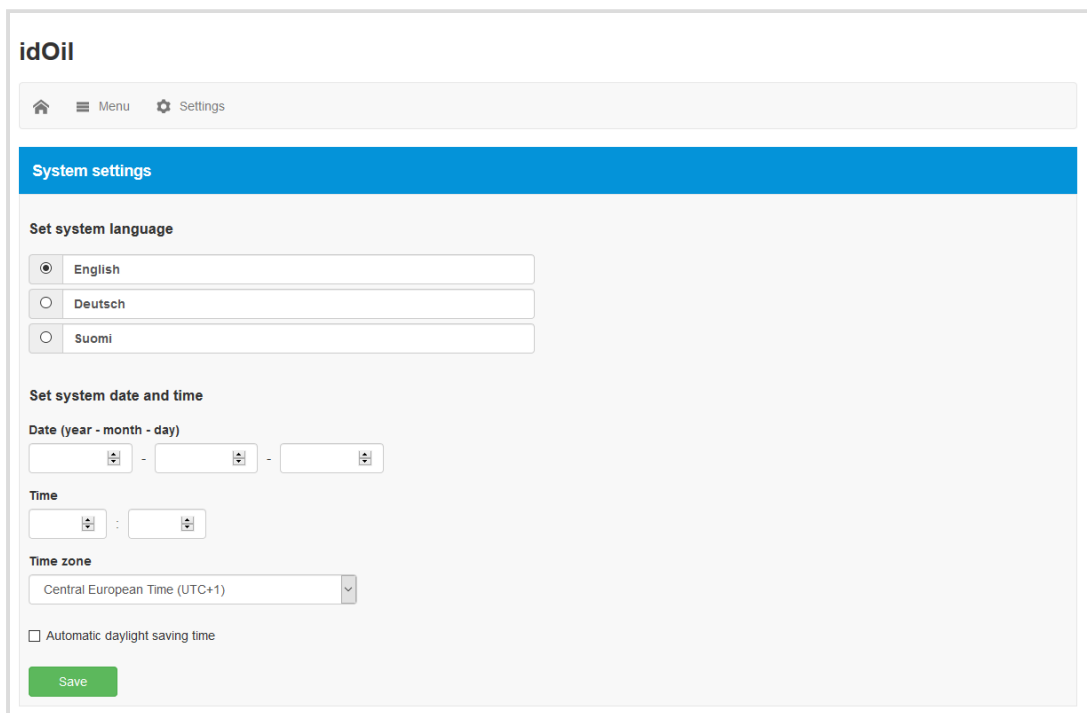

The screenshot shows the 'idOil' web interface for system settings. At the top, there is a navigation bar with a home icon, a 'Menu' button, and a 'Settings' button. Below this is a blue header bar labeled 'System settings'. The main content area is divided into sections: 'Set system language' with radio buttons for 'English' (selected), 'Deutsch', and 'Suomi'; 'Set system date and time' with fields for 'Date (year - month - day)', 'Time', and 'Time zone' (set to 'Central European Time (UTC+1)'); and a checkbox for 'Automatic daylight saving time'. A green 'Save' button is located at the bottom of the form.

Figure 25. System settings

► Do the following:

1. Select the desired language as the active language. The default is English.
2. In the Set system date and time fields, enter the
 - Date: year-month-day
 - Time: hours-minutes
3. Select the Time zone.
4. If necessary, activate the Automatic daylight saving time.
5. Finish by pressing the Save button.

6.3.3. Sensor naming and identification

Once the system settings have been set, the control unit switches to sensor identification mode and requests a password as shown in the figure.

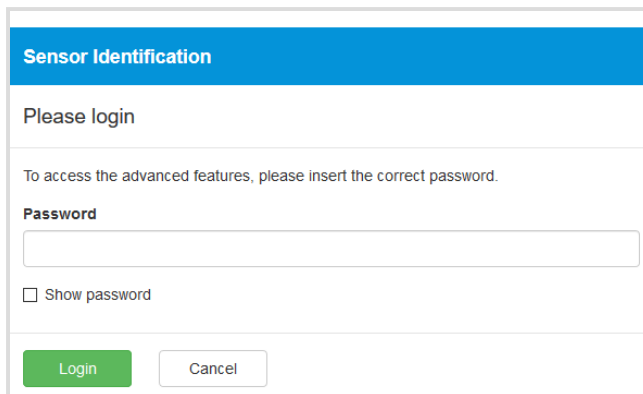

The screenshot shows a web interface titled "Sensor Identification". It features a blue header bar with the title. Below the header, the text "Please login" is displayed. A message states: "To access the advanced features, please insert the correct password." There is a "Password" label above a text input field. Below the input field is a checkbox labeled "Show password". At the bottom, there are two buttons: a green "Login" button and a white "Cancel" button.

Figure 26. Sensor identification; enter password

► Enter 1234 in the password field and press the Login button.

If no sensors have been identified before, the view shown below is displayed.



The screenshot shows the idOil dashboard. The top left corner displays the "idOil" logo, and the top right corner shows the date and time "2018-06-11 09:59". Below the header, there is a navigation bar with a home icon, a "Menu" button, and a "Settings" button. The main content area has a blue header bar titled "Sensor Identification". Below this, there are two buttons: a green "Detect sensors" button and a blue "Help" button. At the bottom, a message states "No sensors found".

Figure 27. Sensor identification; no sensors found.

► Press the Detect sensors button. The control unit begins to detect connected sensors.

After detection, the message shown in the figure is displayed. In the example, three sensors are connected.

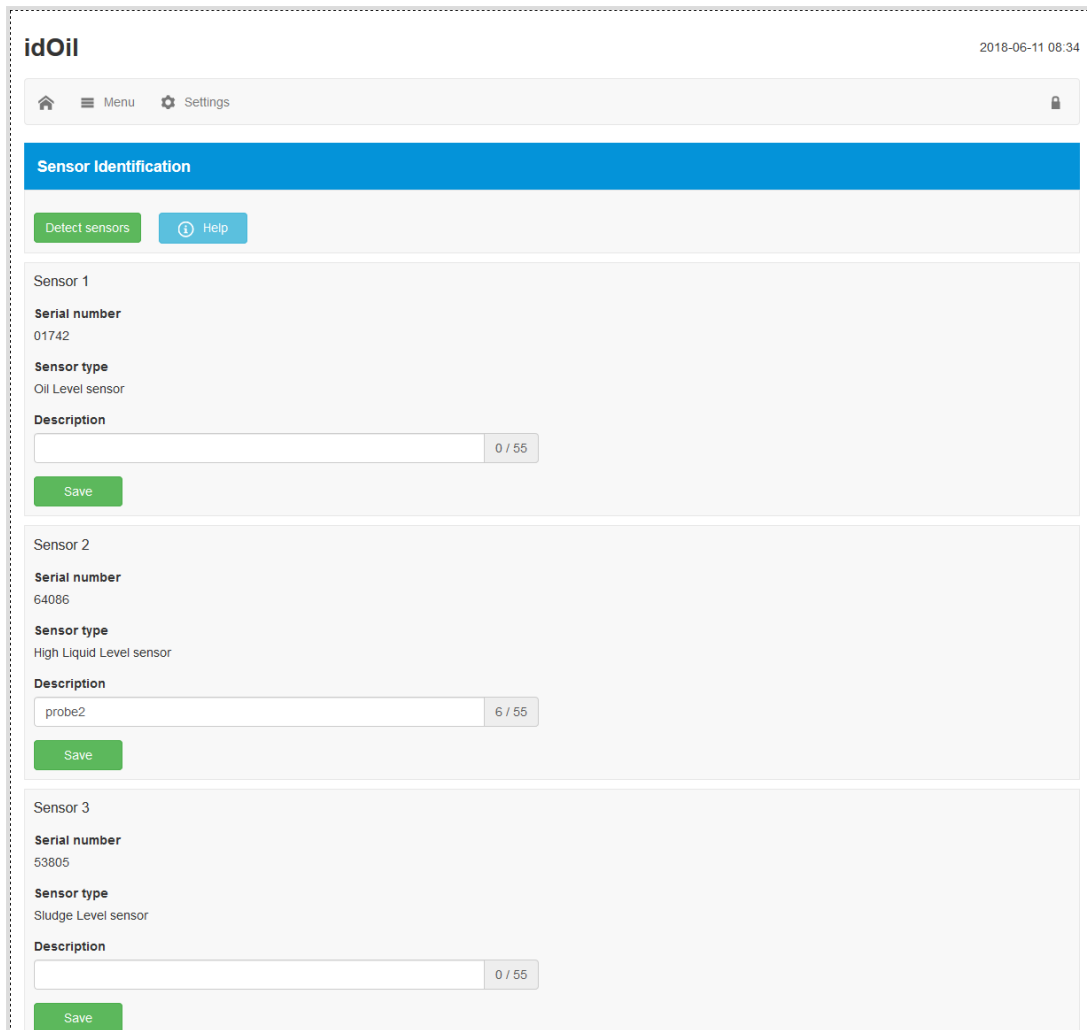

The screenshot shows the 'idOil' web interface. At the top right, the date and time are '2018-06-11 08:34'. Below the header, there are navigation icons for home, menu, and settings. The main section is titled 'Sensor Identification' and contains two buttons: 'Detect sensors' (green) and 'Help' (blue). Below this, three sensor entries are listed:

- Sensor 1**
 - Serial number: 01742
 - Sensor type: Oil Level sensor
 - Description: [Empty text box] 0 / 55
 - Save button (green)
- Sensor 2**
 - Serial number: 64086
 - Sensor type: High Liquid Level sensor
 - Description: probe2 6 / 55
 - Save button (green)
- Sensor 3**
 - Serial number: 53805
 - Sensor type: Sludge Level sensor
 - Description: [Empty text box] 0 / 55
 - Save button (green)

Figure 28. Sensor identifications; sensors found

▶ If necessary, enter identifiers for the sensors in the Description field and press the Save button.

If the control unit does not identify all connected sensors.

▶ Check the sensor connections.

▶ Once you have conducted the check, press the Detect sensors button again.



The control unit will look for the sensors for approx. 2 minutes, unless it has already found three sensors. After the search, the device shows the number of sensors found in the browser view and the System OK message in the control unit display.

The sensor detection can be interrupted by pressing the Stop detection button.

idOil 2018-06-11 08:39

Home Menu Settings

Sensor Identification

Detect sensors Stop detection Help

Sensor 1

Serial number
01742

Sensor type
Oil Level sensor

Description
 0 / 55

Save

Sensor 2

Serial number
64086

Sensor type
High Liquid Level sensor

Description
 0 / 55

Save

Figure 29. Sensor identification, stop detection

Once all connected sensors have been identified and individual descriptions have been provided for them:

► Press the home screen button in the upper left corner: 

The idOil separator alarm system is now operational at factory settings.

7. Operation

After installation and commissioning, the idOil separator alarm system functions entirely independently and does not require constant monitoring.

The system state, alarms and failures can be viewed on the control unit display and through the browser-based user interface.

The backlight of the local display is normally off. The backlight can be activated by pressing the reset/test button briefly.

The alarm information can be connected to automation systems through relays and mobile connections.

All of the system's connections and functions are described in the figure below and in more detail in the following sections.

The operation of the device depends on the settings made through the browser-based user interface. Unless otherwise indicated, this section describes device operation in accordance with factory settings. See Section Commissioning.



- 1 Local display
- 2 Reset and test button
- 3 Network feed lead-through
- 4 Relay output lead-throughs 2 pcs
- 5 Sensor connections 3 pcs (blue)

Local WLAN connection for access to the browser-based user interface.

3G modem for remote settings and alarm messaging by SMS (option).

Figure 30. Features of the idOil control unit

7.1. Local display and alarms

Local display

The four-row local display in the front panel presents information on system status, possible alarms and faults. In the event of an alarm, the type of the sensor that activated the alarm is shown (high liquid level, oil or sludge). In addition to this, the display can be used to show the customer information specified in the context of commissioning; company and telephone number (not a factor setting).

If the time has been set, the device shows a time stamp for each alarm.

If the maintenance alarm is in use (not a factory setting), the display can show the next maintenance month. The maintenance date is presented in the browser-based user interface.

If the details to be displayed do not fit the screen at the same time, they will be distributed to multiple pages. In this case, the lower right corner of the display indicates the current page number and the total page count, e.g. 1/2. The page is changed automatically every 5 seconds.

Alarms

In alarm and fault situations:

- The alarm information is shown on the local display.

After the alarm delay (10 s):

- The buzzer lets out an alarm sound and the backlight of the display begins to flash.
- The relays are switched to the alarm position. Both relays are de-energised in alarm and fault situations (factory setting). The relays are of the failsafe type, which means that they also enter the alarm state when operating power is lost.
- If the 3G module (idOil-30 3G model, option) is included, the device sends an alarm and fault message to the recipient's telephone number.



The alarms can be divided into three groups: level, fault and maintenance alarms.

- In a level alarm the sensor in the separator has detected that the liquid level being monitored has reached the alarm limit (high liquid level, oil or sludge).
- In a fault alarm the control unit has detected a fault in the sensor circuit. The monitoring covers the communication between the control unit and sensor as well as short circuits and breaks.
- In a maintenance alarm the month counter has reached the limit value (1, 3, 6 or 12 months). As a factory setting this function is not in use.

7.2. Resetting an alarm

An alarm can be reset by pressing the test button in the cover.

Resetting an alarm deactivates the buzzer. However, the buzzer is always reactivated for 10 s every 24 hours until the cause for the alarm is eliminated.

-  The relays do not change their state when an alarm is reset with the reset button.
-  The operation of the buzzer and relays can be changed through the browser-based user interface. See Section Using the browser-based user interface.

7.3. Using the browser-based user interface

The following sections describe the use of the idOil browser-based user interface.

-  The process of establishing a connection to the browser-based interface is described in the section Commissioning through the browser-based interface.

7.3.1. Home screen

The browser-based interface always starts in the home screen shown in the figure below. You can also access the home screen by pressing the 🏠 icon in the upper left corner.

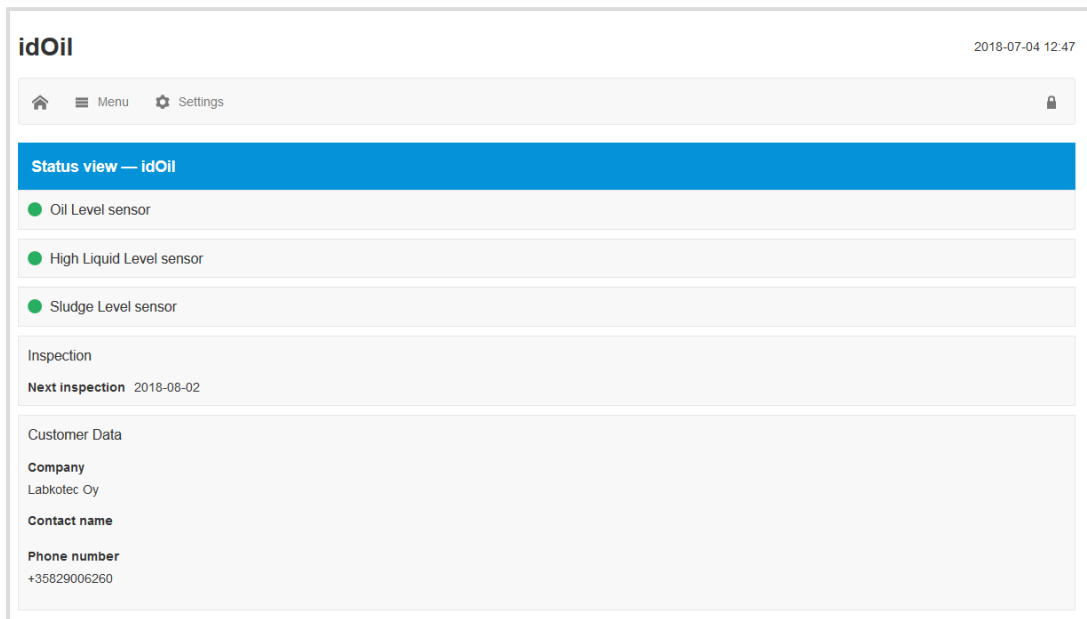



Figure 31. Home screen

The items listed in the following table are shown in the home screen. The menus are described in more detail in the sections below.

idOil	Type name of the control unit
2017-01-04 16:45	Date and time of the device's internal clock
	Home screen button; by clicking this icon, you can return to the home screen
Menu	Selection of menu options
Settings	Settings menu. Requires logging in with the maintenance user password.
	<p>The idOil device features two user levels:</p> <p>Basic user:</p> <ul style="list-style-type: none"> • The upper right corner of the home screen top bar does not show this symbol. • No rights to configure the device, except time and language settings. <p>Maintenance user:</p> <ul style="list-style-type: none"> • The lock system is shown in the upper right corner of the home screen top bar. The user has logged in with the maintenance user password. • The right to configure control unit settings in the Settings menu.
Status view	<p>The status of the sensors connected to the device is shown under the Status view heading:</p> <ul style="list-style-type: none"> • Green means no alarm. • Red means an alarm or fault status in the sensor. The cause of the alarm or fault and the time of the alarm is shown below the sensor.
Inspection	Below the Inspection menu, the device shows either the time of the next scheduled inspection or the latest inspection alarm if the scheduled inspection date is in the past and the alarm has not been reset. See Settings.
Customer data	This section shows the customer and contact information set in the device.

7.3.2. Menu list

The Menu list features the functions shown in the figure below.



Basic users can access the Menu options.



Figure 32. Menu list

7.3.2.1. Alarm log

The alarm log records the times of the alarm and fault situations, the reset times, and the times at which the alarms and faults are eliminated. The following events are recorded in the alarm log:

- Sensor alarm situation.
Note! Alarms caused during maintenance are recorded in the inspection log.
- Sensor fault
- Sensor bus short-circuit
- Test alarm (reset button has been pressed for 3 s)
Note! Alarms caused during maintenance are recorded in the inspection log.
- Power off/on (start and stop time of a power outage)

The buttons at the bottom of the alarm log perform the following functions:

- Load more items: Shows previous alarms if all alarms and faults do not fit in the browser window at the same time.
- Update: The alarm log view returns to the initial view which shows the latest alarms.
- Save report: Saves the alarm log in the .csv format.

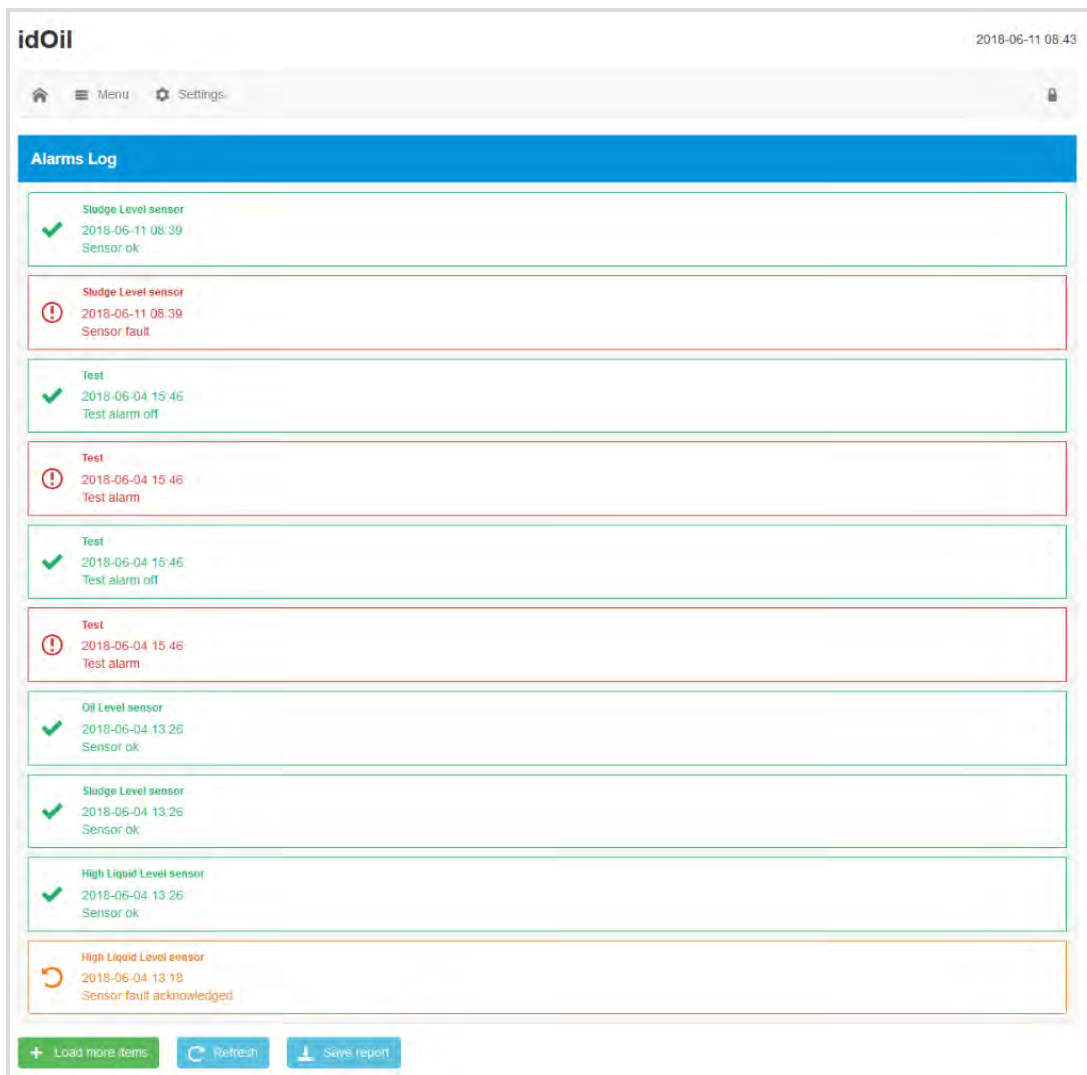

Figure 33. Alarm log

7.3.2.2. Inspection

This function adds an inspection measure in the device's inspection log. Recording inspection measures resets the inspection counter.

- ▶ Press the Start inspection button to activate the inspection form.
- ▶ In the Inspection notes field, enter the inspection measures conducted and, in the Inspector name field, enter your name.
- ▶ End the inspection measure with the Inspection completed button. The device will switch to the Inspection log view.

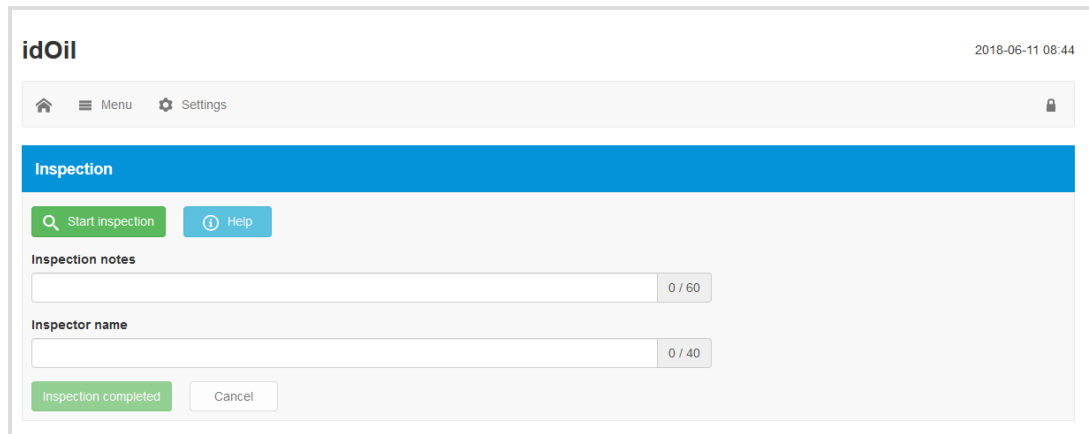

Figure 34. Inspection

The inspection can also be conducted as a quick operation without using the browser user interface. When the inspection alarm is active, the inspection can be conducted with the test operation (see Test function). Press the test/reset button in the front panel for 3 seconds and release the button. The inspection interval counter and the inspection alarm is now reset.

7.3.2.3. Inspection log

The Inspection log view shows the latest inspection note first. Alarms during inspection are shown in the inspection log. These alarms are not shown in the alarm log.

The latest inspection note can be edited but this will not change the time stamp. Old inspection notes can no longer be edited.

► Press the Save button after any possible changes.

The buttons at the bottom of the inspection log perform the following functions:

- Load more items: Shows prior inspection measures if it is not possible to fit all of them in the browser window at the same time.
- Update: The Inspection log view returns to the initial view which shows the latest inspection measures.
- Save report: Saves the inspection log in the .csv format.

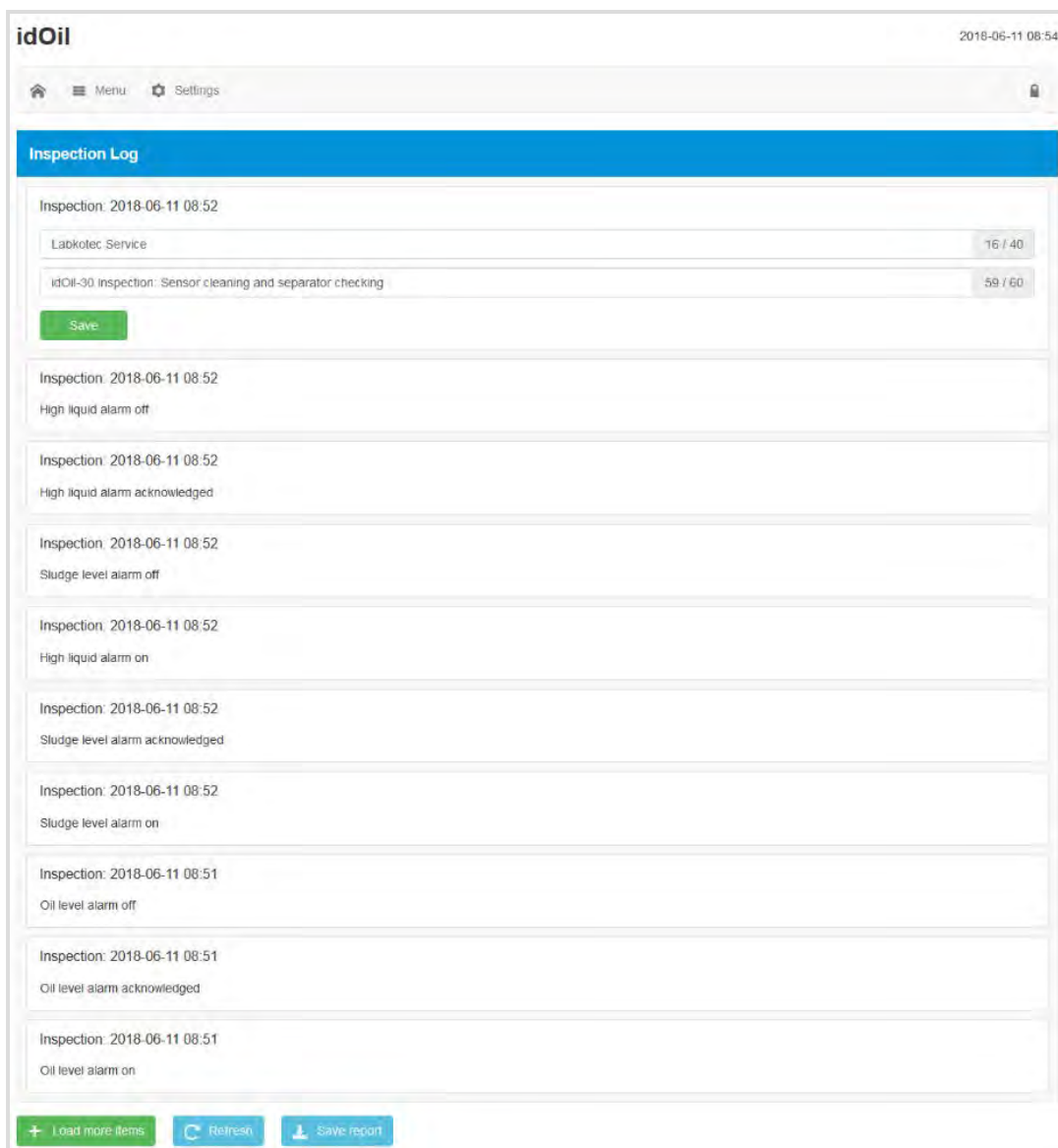

Figure 35. Inspection log

7.3.2.4. Language

You can select one of the supported languages in the Language menu.

► Select the desired language and press the Select button.

This will change the language of the browser interface and local display to the selected language.

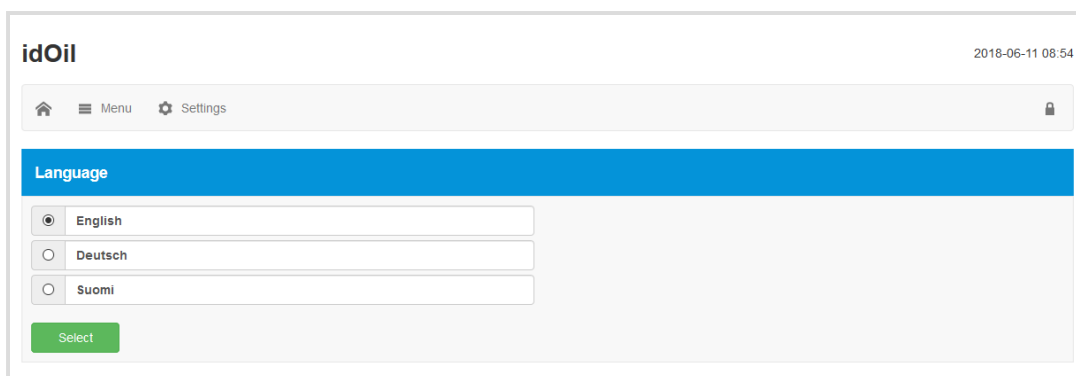

Figure 36. Language selection

7.3.2.5. Date and time

The control unit's date, time, time zone and automatic daylight saving setting can be set and updated in this view.

► Make the necessary changes and press the Save button.

The date and time must be set (required information) when the first WLAN connection to the control unit is established.

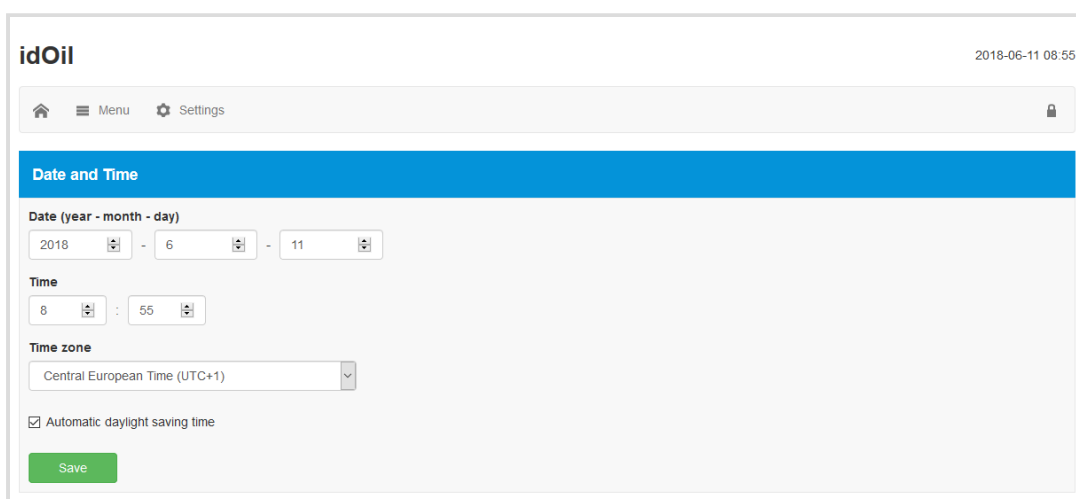

Figure 37. Date and time

7.3.3. Settings menu

The functions in the Settings menu can be used to change the control unit settings. The settings can be accessed with the maintenance user's password.

► Press the Settings menu in the home screen, at which point the device requests a password.



The maintenance user password is 1234.

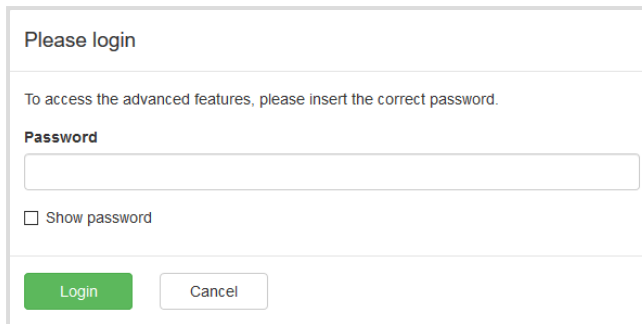

Please login

To access the advanced features, please insert the correct password.

Password

Show password

Login Cancel

Figure 38. Password prompt

► Enter the password and press the Login button.

The Settings menu features the functions shown in the figure below. The functions are described in more detail in the following paragraphs.

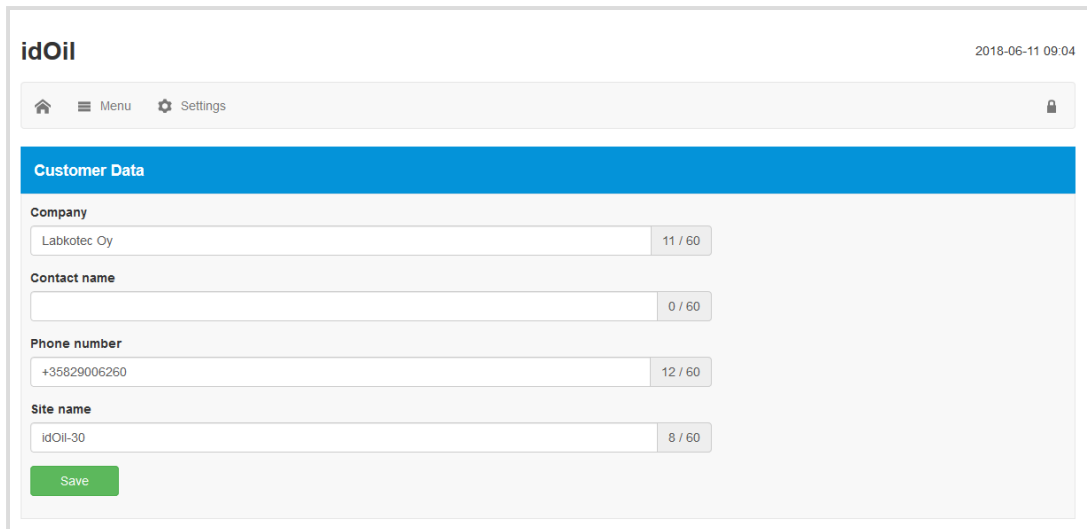

Figure 39. Settings menu

7.3.3.1. Customer data

In the Customer data menu, you can enter the following information in the device:

- **Company:** The name of the device owner, supplier or maintenance company, for example. The name is shown in the home screen and the control unit display. The display shows the first 16 characters.
- **Contact name:** The name of the contact person for the above company, for example. The name is shown in the home screen but not the control unit display.
- **Phone number:** The contact person's phone number. The number is shown in the home screen and the control unit display.
- **Site name:** A unique name can be entered for the device. The name is shown in the home screen, in the Status viewbar and the loaded reports, but not the control unit display.



The screenshot shows the 'idOil' interface with a header bar containing a home icon, a 'Menu' button, and a 'Settings' button. The date '2018-06-11 09:04' is displayed in the top right corner. Below the header is a blue bar labeled 'Customer Data'. The form contains four input fields: 'Company' (Labkotec Oy, 11 / 60), 'Contact name' (empty, 0 / 60), 'Phone number' (+35829006260, 12 / 60), and 'Site name' (idOil-30, 8 / 60). A green 'Save' button is located at the bottom of the form.

Figure 40. Customer data

7.3.3.2. Inspection settings

In the Inspection settings menu, you can set the inspection period counter. You can select between:

- never (factory setting, inspection period not used)
- 1 month
- 3 months
- 6 months
- 12 months

► Select the desired inspection period and press the Save button.

The selection (with the exception of "never") activates the inspection period counter, which will activate the inspection alarm after the selected interval. The time of the maintenance is shown in the home screen (year-month-day) and the control unit display (year-month).

The inspection counter can only be reset once the inspection alarm has been activated. In other words, an inspection cannot be performed before the activation of the alarm (this does not reset the counter).



The screenshot shows the 'idOil' interface with a header bar containing a home icon, a 'Menu' button, and a 'Settings' button. The date '2018-06-11 09:05' is displayed in the top right corner. Below the header is a blue bar labeled 'Inspection Settings'. The form contains one dropdown menu labeled 'Inspection period' with '1 month' selected. A green 'Save' button is located at the bottom of the form.

Figure 41. Inspection settings

7.3.3.3. Alarm settings

In the Alarm settings menu, you can change the following alarm settings:

- Alarm buzzer: Off/On. If Off is selected, the buzzer will not sound upon an alarm.
- Alarm repeat (24 h): Off/On. If On is selected, the alarm will be repeated 24 hours after a reset, if the cause of the alarm has not been eliminated.
- Alarm delay for sensors. Delay between sensor detection and the activation of the alarm buzzer and relay. You can use seconds, minutes or hours for the setting.
- Alarm reset button: Off/On. If Off is selected, the alarm cannot be reset by pressing the reset button in the front panel of the control unit (i.e. the buzzer will keep sounding the alarm).

The screenshot displays the 'idOil' web interface for alarm configuration. At the top, the title 'idOil' and the timestamp '2018-06-11 09:06' are visible. A navigation bar includes a home icon, a 'Menu' button, and a 'Settings' button. The 'Alarm Settings' section is highlighted in blue. It contains the following settings:

- Audio alarm:** A toggle switch is currently turned 'On'.
- Alarm repeat (24 h):** A toggle switch is currently turned 'On'.
- Sensor 1 / Oil Level sensor:** The 'Alarm delay' is set to 10 seconds. A green 'Save' button is located below the input fields.
- Sensor 2 / High Liquid Level sensor:** The 'Alarm delay' is set to 10 seconds. A green 'Save' button is located below the input fields.
- Sensor 3 / Sludge Level sensor:** The 'Alarm delay' is set to 10 seconds. A green 'Save' button is located below the input fields.
- Alarm reset button:** A toggle switch is currently turned 'Enabled'.

Figure 42. Alarm settings

7.3.3.4. Relay settings

The following functions related to relays 1 and 2 can be set in the Relay settings menu:

- Sensors connected to relays: Off/On.
- Relay action in case of alarm and failure: Off/On.
- Relay action in case of an inspection warning: Off/On.
- Relay return when alarm is reset by pressing the reset button: No/Yes.

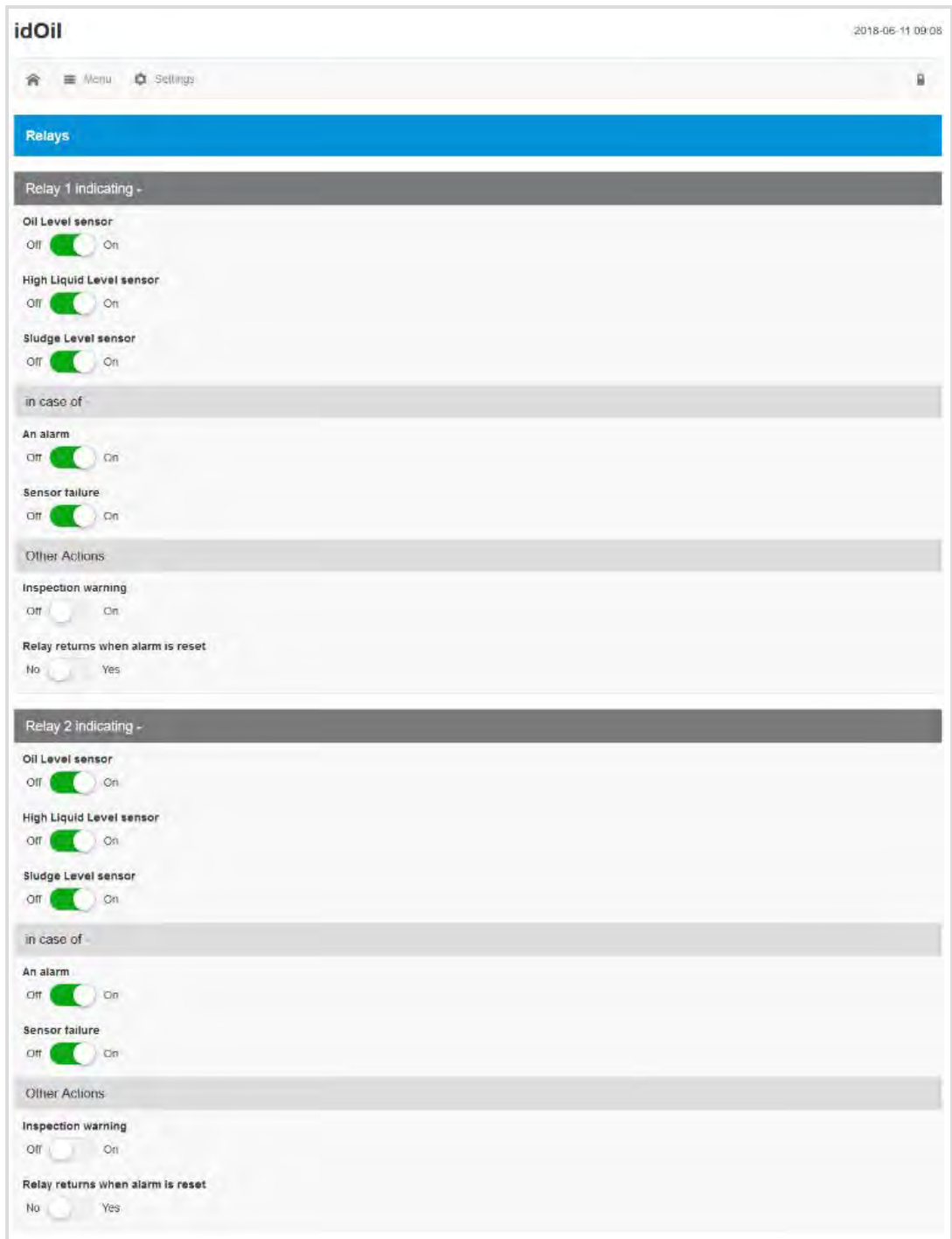

Figure 43. Relay settings

7.3.3.5. Software update

The software of the control unit can be updated through the user interface. The Software update menu shows the current software version and the available language options.



Figure 44. Software update

Upload the new software as follows:

- ▶ Press the Upload new software package button.
- ▶ Select the software file to be uploaded (format: ".pkg") from the terminal device memory.

The software will now be uploaded to the control unit. The uploading process may take several minutes.

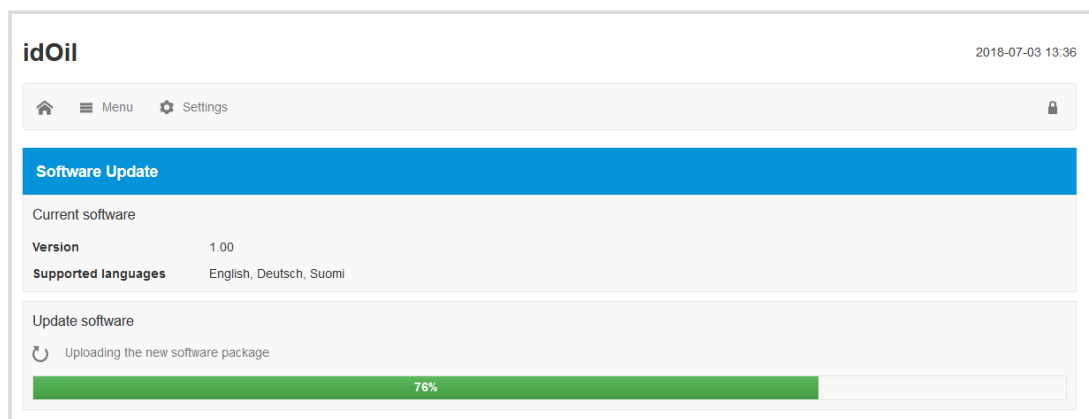

Figure 45. Software upload

Once the software has been uploaded into the control unit's memory, the display will show the current software version and the new version to be updated (see next figure).

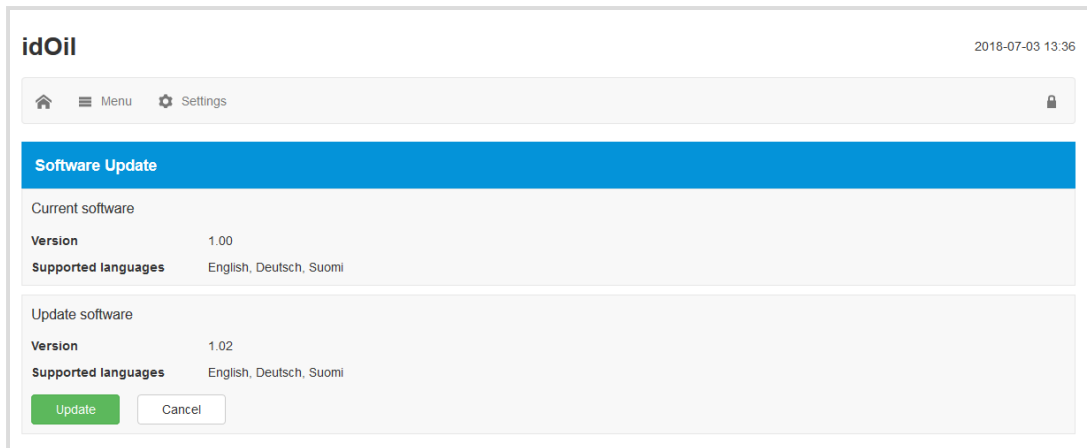

Figure 46. Software uploaded to the control unit

- ▶ Press the Update button.

The software update begins and the message in the figure below is shown in the display. The various phases of the software update are presented in the control unit display.

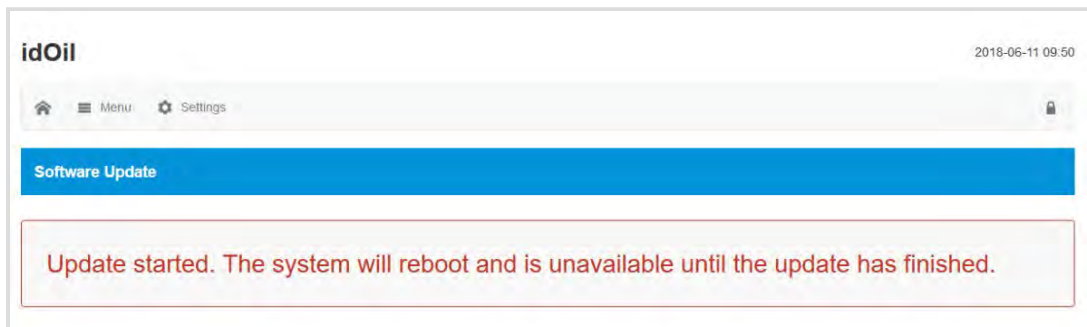

Figure 47. Software update started

Once the programming has been completed, the control unit reboots.

- ⓘ The WLAN connection to the device is lost during a software update.

- ▶ Establish the WLAN connection again according to the instructions in the Commissioning through the browser-based interface section.

7.3.3.6. Restoring factory settings

In the Factory settings menu you can restore the control unit's original factory settings.

- ⓘ The factory settings of the idOil device are described in the section Commissioning
- ⓘ Restoring the factory settings clears the alarm and maintenance log. The sensors connected to the control unit must also be identified again.

You can restore the factory settings as follows:

- ▶ Check the Restore factory settings box and press the Restore settings button (see the next figure).

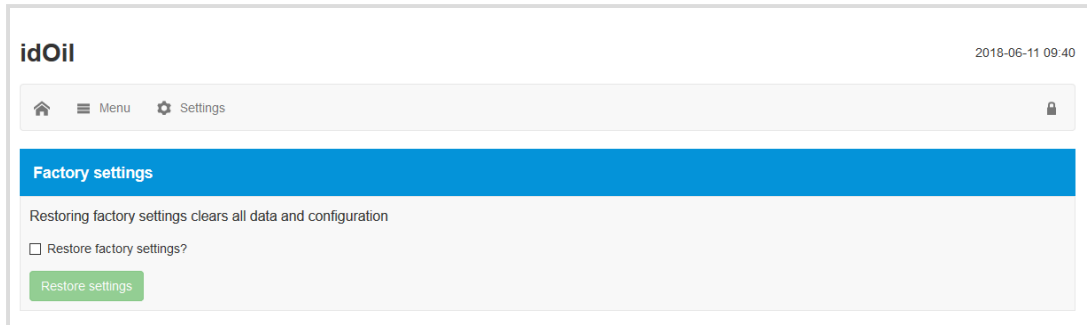

Figure 48. Restoring factory settings

- ▶ Confirm the restoration of the factory settings by pressing Yes, I want to clear all data button.

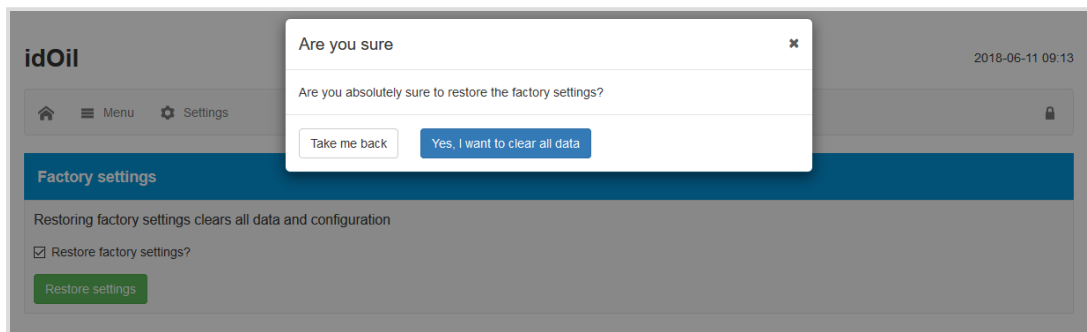

Figure 49. Factory settings - confirm restoration

After this, the system shows the following message: "Restoring factory settings. Please reload the web page in a few moments. If the WLAN connection is lost, reconnect the device."

- ▶ If necessary, establish the WLAN connection in accordance with section Establishing a WLAN connection .
- ▶ Configure the system settings and perform sensor identification.

7.3.3.7. WLAN settings

If the WLAN connection is poor, several devices may be using the same WLAN channel.

- ▶ You can change the WLAN channel by using the WLAN settings menu to select another channel and pressing the Save button.



Figure 50. WLAN settings

- ▶ Establish the WLAN connection again according to the instructions in the Establishing a WLAN connection section.

7.3.3.8. 3G settings (idOil-30 3G model only, option)

The 3G settings can be found in the M2M settings menu, if the idOil device features a 3G module.

The following settings can be set in the M2M settings menu:

- Receiver phone number (max. 5 phone numbers):
 - ▶ Press the Add button.
 - ▶ Enter the phone number.
 - ▶ Press the Save button.
- SMS communication centre number:
 - The idOil device detects the SMS communication centre number automatically. If the operator is using multiple communication centre numbers, provide another number and press the Save button.
- PIN code:
 - If the PIN code prompt for the SIM card is enabled, enter the PIN code and press the Save button. The idOil device will remember the PIN code after this.
- SMS reporting:
 - Enable reporting: No/Yes
 - Frequency: this sets the interval at which the idOil device sends a situation report to the set recipient phone numbers.
 - Sending time: this sets the time at which the situation report should be sent.
- LabkoNet
 - Enable LabkoNet service: Off/On



To activate the LabkoNet service, please contact the Labkotec Oy customer service (info@labkotec.fi).

idOil 2018-06-11 09:16

Home Menu Settings Lock

M2M Settings

Receiver phone number

SMS communication center number

PIN code

SMS reporting

Enable reporting

No Yes

Frequency (x days)

Sending time

:

LabkoNet

Enable LabkoNet service

Off On

Figure 51. 3G settings

8. Maintenance

-  The operation of the separator system and alarm device must be checked at least every 6 months by experienced personnel.

The following is recommended in conjunction with the inspection:

- functional check of the idOil alarm device with the test function and sensor (see Section Functional test)
- sensor cleaning (see Section Maintenance measures)

-  The idOil control unit should be placed in maintenance mode through the browser-based operating system before inspection and sensor cleaning so that all alarms during testing are recorded in the inspection log instead of the alarm log. More information is available in Section Using the browser-based user interface / Inspection.

The idOil control unit and sensors do not have wearing or replaceable parts.

The device does not include replaceable fuses.

8.1. Functional test

The functional test must be performed as follows:

- ▶ Open the control unit's browser-based user interface with your terminal device.
- ▶ Navigate to Menu -> Inspection and click the button Start inspection.
- ▶ Perform the functional test by pressing the test button and with sensors (see following paragraphs).
- ▶ Record the desired information in the text fields of the Inspection page.
- ▶ End the inspection by clicking the Inspection complete button.

8.1.1. Test function

The test function creates a test alarm, which is used to ensure the appropriate functioning of the idOil device and any other possible devices or systems controlled by its relays in an alarm situation.

The function can only be executed if no alarms are active. At this point, the screen reads SYSTEM OK.

Activating the test function:

- ▶ Press the reset/test button continuously for 3 seconds.

The display shows the message TEST ALARM, the backlight flashes and the relays are switched to the alarm state for 3 seconds.

If the 3G module (idOil-30 3G model, option) is included, the device sends a test alarm SMS to the recipient's telephone number.

If the inspection alarm is active, this operation will conduct the inspection as a quick operation. Then this test function will reset the inspection interval counter and the inspection alarm (see also Inspection).

8.1.2. Functional test with sensors

The operation of the idOil device and sensors can be checked comprehensively by simply simulating an actual alarm situation.

Depending on the sensor type, the functional test can be conducted as follows:

1. idOil-LIQ (high liquid level):
 - ▶ Immerse the sensor in oil or water.
2. idOil-OIL (oil):
 - ▶ Immerse the sensor in oil. If this is not possible, lift the sensor into the air.
3. idOil-SLU (sludge):
 - ▶ Immerse the sensor in sand or sludge. If this is not possible, lift the sensor into the air.



The alarm will be activated after the delay (factory setting: 10 s).



Remember to set the device in maintenance mode so that the alarms during the maintenance measures are recorded in the inspection log instead of the alarm log.

8.2. Maintenance measures

The sensors must be cleaned in conjunction with maintenance inspections. You can clean the sensors with washing up liquid and a washing up brush, for example.



Do not use corrosive substances to clean the sensors.



Mark the maintenance measures in the control unit's inspection log.

8.3. Troubleshooting



DANGER OF ELECTRICAL SHOCK!

Adhere to the electrical safety regulations!

PROBLEM: The display is dark.

Explanation: The voltage received by the device is too low, or the fuse has blown.

Action:

1. First check that the voltage has not been cut by the mains switch.
2. Measure the voltage from connectors N and L1. It should be 100–240 V AC.



EXPLOSION HAZARD!

Observe the installation and maintenance instructions for explosive atmospheres!
The measuring device must be Exi classified if the sensor is in an explosive area.

PROBLEM: Fault alarm on (the backlight of the display is flashing)

Explanation: The sensor cable is short-circuited, cut or disconnected from the connector. The sensor could also be damaged.

Action:

1. Measure voltage separately from that sensor's sensor connectors. The voltage should be 9.0–11.5 V.
2. If the voltage is correct, measure the current received by the sensor. It should settle between 6.0–8.0 mA within 10 seconds.
3. Reconnect the disconnected wire after the measurement.



The sensor cable wires are not numbered because the voltage polarity (+ or -) makes no difference.

PROBLEM: The browser-based user interface does not open in the IP address: 192.168.0.1 of your mobile terminal device internet browser.

Explanation: The mobile terminal's internet browser tries to use the mobile data feature.

Action:

1. Turn off the mobile data feature from the settings of mobile terminal device or
2. Connect the mobile terminal device to the flight mode. Check that the WLAN will stay on.

If problems occur, contact Labkotec Oy's service department.

9. Technical specifications

9.1. Technical specifications for the idOil control unit

TECHNICAL SPECIFICATIONS idOil-30	
Dimensions	175 mm x 125 mm x 75 mm (w x h x d)
Enclosure	IP 65, material: polycarbonate
Weight	780 g (900 g 3G module version)
Operating environment	Temperature: -30°C...+60°C Max. elevation above sea level 3,000 m Relative humidity RH 100%
Operating voltage	100–240 V AC \pm 10%, 50/60 Hz The device does not have a mains switch. UL/CSA: Supply cable 3 x 1,5-2,1 mm ² (AWG16-AWG14). Supply voltage max fuse size 10 A. Other areas: Supply cable 3 x 1,5-2,5 mm ² (AWG16-AWG13). Supply voltage max fuse size 16 A. The internal fuses cannot be replaced.
Power consumption	Max. 12 VA
Sensors	Digital Labkotec idOil sensors
Relay outputs	5 A, 250 V AC / 30 V DC, 100 VA Potential-free changeover contacts.
Display	Character-based 20x4 LCD screen for displaying alarm and fault states.
User interface	Browser-based user interface for displaying alarm and fault states and configuring the device over a Wi-Fi connection (2.4GHz; 802.11 b/g/n) IP address: 192.168.0.1
3G module (idOil-30 3G model, option)	900/1800/2100 MHz SMS and LabkoNet data transfer
Electrical safety	IEC/EN 61010-1, Class I, CAT II UL 61010-1 CAN/CSA-C22.2 NO. 61010-1-12
EMC	IEC/EN 61000-6-2 IEC/EN 61000-6-3
RED	EN 300 328 EN 301 511 (3G module version) EN 301 908-1 (3G module version) EN 301 908-2 (3G module version)

ATEX and IECEx	VTT 16 ATEX 018X IECEX VTT 16.0005X
Ex classification Special terms (X)	⊕ II (1) G [Ex ia Ga] IIB Ta = -30 °C...+60 °C
Exi connection values	U _o = 14.5 V, I _o = 78 mA, P _o = 367 mW, R = 243 Ω Output voltage's characteristic curve is trapezoidal
Maximum values in explosion group IIB	Co = 4.0 μF, Lo = 16.7 mH
See system diagram Appendix A	
Manufacturing year: Please see the serial number on the type plate.	xxxxxxx x xxx xx YY x where YY = manufacturing year (e.g. 18 = 2018)

9.2. Technical specifications idOil-LIQ high liquid level sensor

TECHNICAL SPECIFICATIONS idOil-LIQ	
Operating principle	Vibration
Enclosure	Enclosure class: IP 68 Materials: PVC, aluminium, PA, CR, Viton
Weight	240 g (incl. 5 m cable)
Temperature	Operation: 0°C...+60°C Environment: -30°C...+60°C
Supply voltage	7,5...16 V DC
Cable	2 x 0.75 mm ² PUR
EMC	IEC/EN 61000-6-2 IEC/EN 61000-6-3
ATEX and IECEx	VTT 17 ATEX 005X IECEX VTT 17.0003X
Ex classification Special terms (X)	⊕ II 1 G Ex ia IIB T5 Ga Ta = -25°C...+60°C
Exi connection values Maximum values in explosion group IIB	U _i = 16 V, I _i = 80 mA, P _o = 400 mW C _i ≤ 5.2 nF, L _i ≤ 1.6 mH
See system diagram Appendix A	
Manufacturing year: Please see the serial number on the type plate.	xxxxxxx x xxx xx YY x where YY = manufacturing year (e.g. 18 = 2018)

9.3. Technical specifications idOil-OIL oil sensor

TECHNICAL SPECIFICATIONS idOil-OIL	
Operating principle	Conductance
Enclosure	Enclosure class: IP 68 Materials: PVC, AISI 316, PA, CR, NBR
Weight	395 g (incl. 5 m cable)
Temperature	Operation: 0°C...+60°C Environment: -30°C...+60°C
Supply voltage	7,5...16 V DC
Cable	2 x 0.75 mm ² PUR
EMC	IEC/EN 61000-6-2 IEC/EN 61000-6-3
ATEX and IECEx	VTT 17 ATEX 004X IECEx VTT 17.0002X
Ex classification Special terms (X)	⊕ II 1 G Ex ia IIA T5 Ga Ta = -39°C...+60°C
Exi connection values Maximum values in explosion group IIB	Ui = 16 V, Ii = 80 mA, Po = 400 mW Ci ≤ 5.2 nF, Li ≤ 1.6 mH
See system diagram Appendix A	
Manufacturing year: Please see the serial number on the type plate.	xxxxxxx x xxx xx YY x where YY = manufacturing year (e.g. 18 = 2018)

9.4. Technical specifications idOil-SLU sludge sensor

TECHNICAL SPECIFICATIONS idOil-SLU	
Operating principle	Ultrasound
Enclosure	Enclosure class: IP 68 Materials: PP, AISI 304/316, PA, NBR, CR, Silicon
Weight	530 g (incl. 5 m cable)
Temperature	Operation: 0°C...+60°C Environment: -25°C...+60°C
Supply voltage	7,5...16 V DC
Cable	2 x 0.75 mm ² PUR
EMC	IEC/EN 61000-6-2 IEC/EN 61000-6-3

ATEX and IECEx	VTT 17 ATEX 006X IECEx VTT 17.0004X
Ex classification Special terms (X)	⊕ II 1 G Ex ia IIB T5 Ga Ta = -25°C...+60°C
Exi connection values Maximum values in explosion group IIB	Ui = 16 V, li = 80 mA, Po = 400 mW Ci ≤ 4.0 nF, Li ≤ 1.6 mH
See system diagram Appendix A	
Manufacturing year: Please see the serial number on the type plate.	xxxxxxx x xxx xx YY x where YY = manufacturing year (e.g. 18 = 2018)

10. Appendices

10.1. APPENDIX A System digram

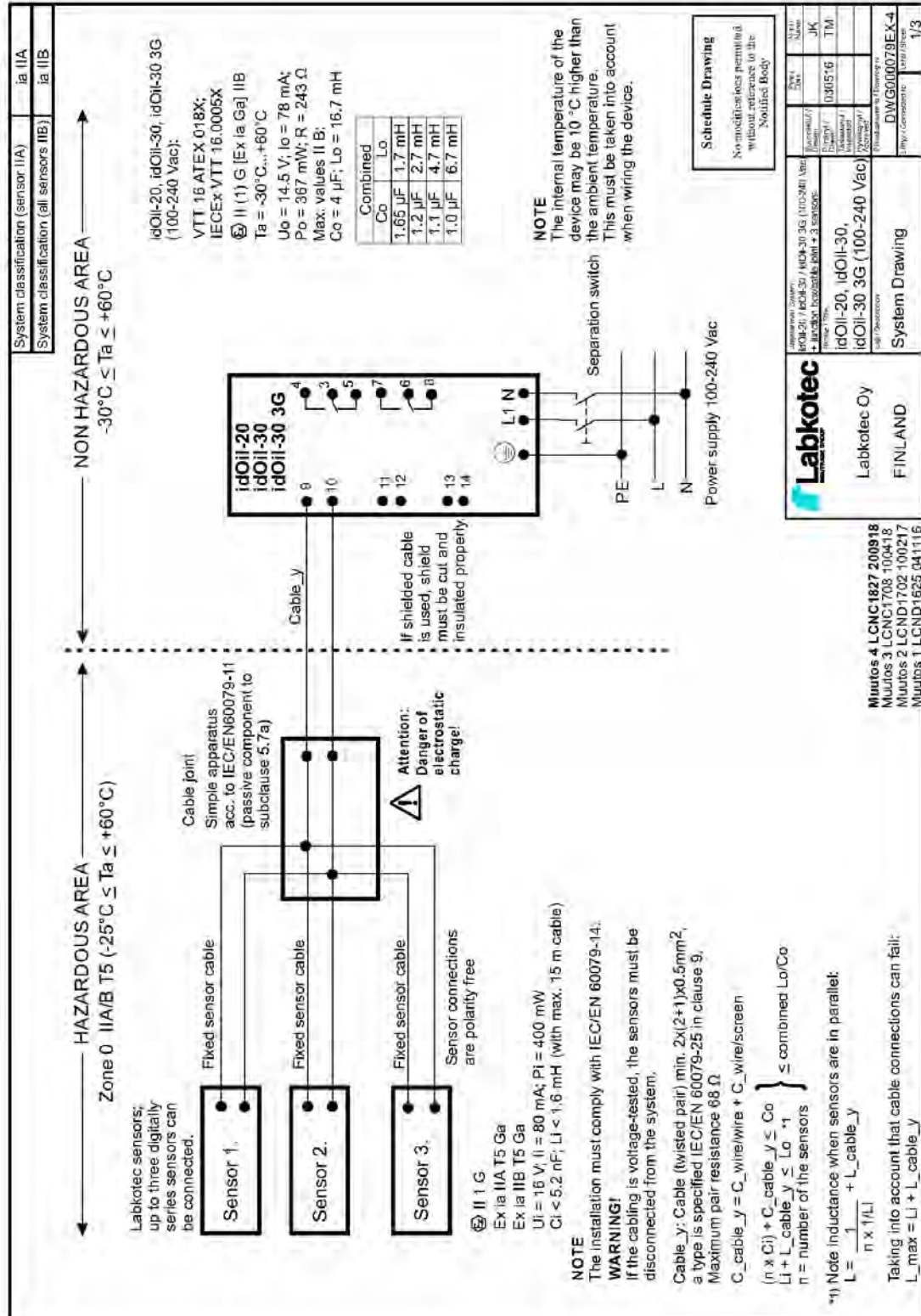

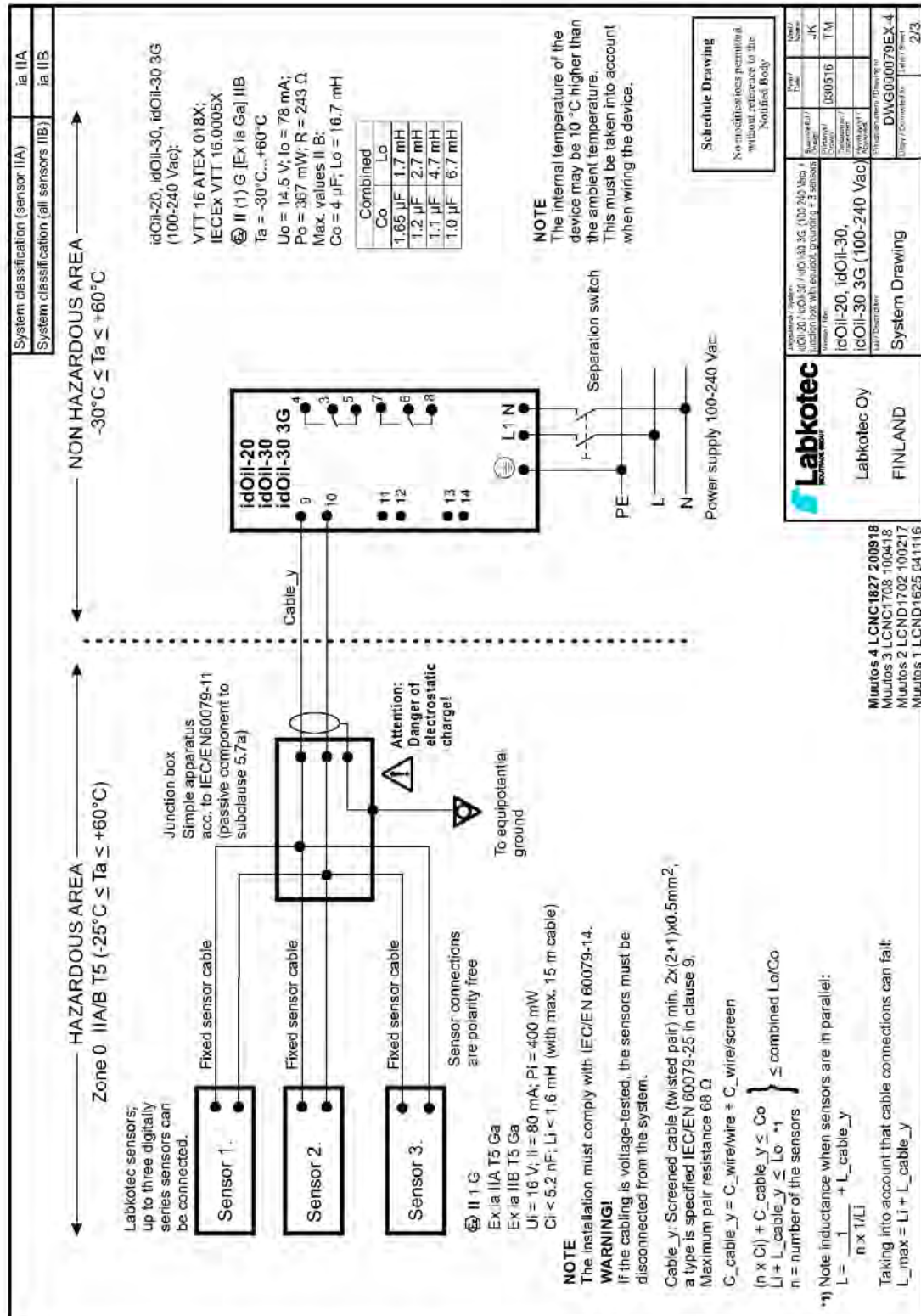

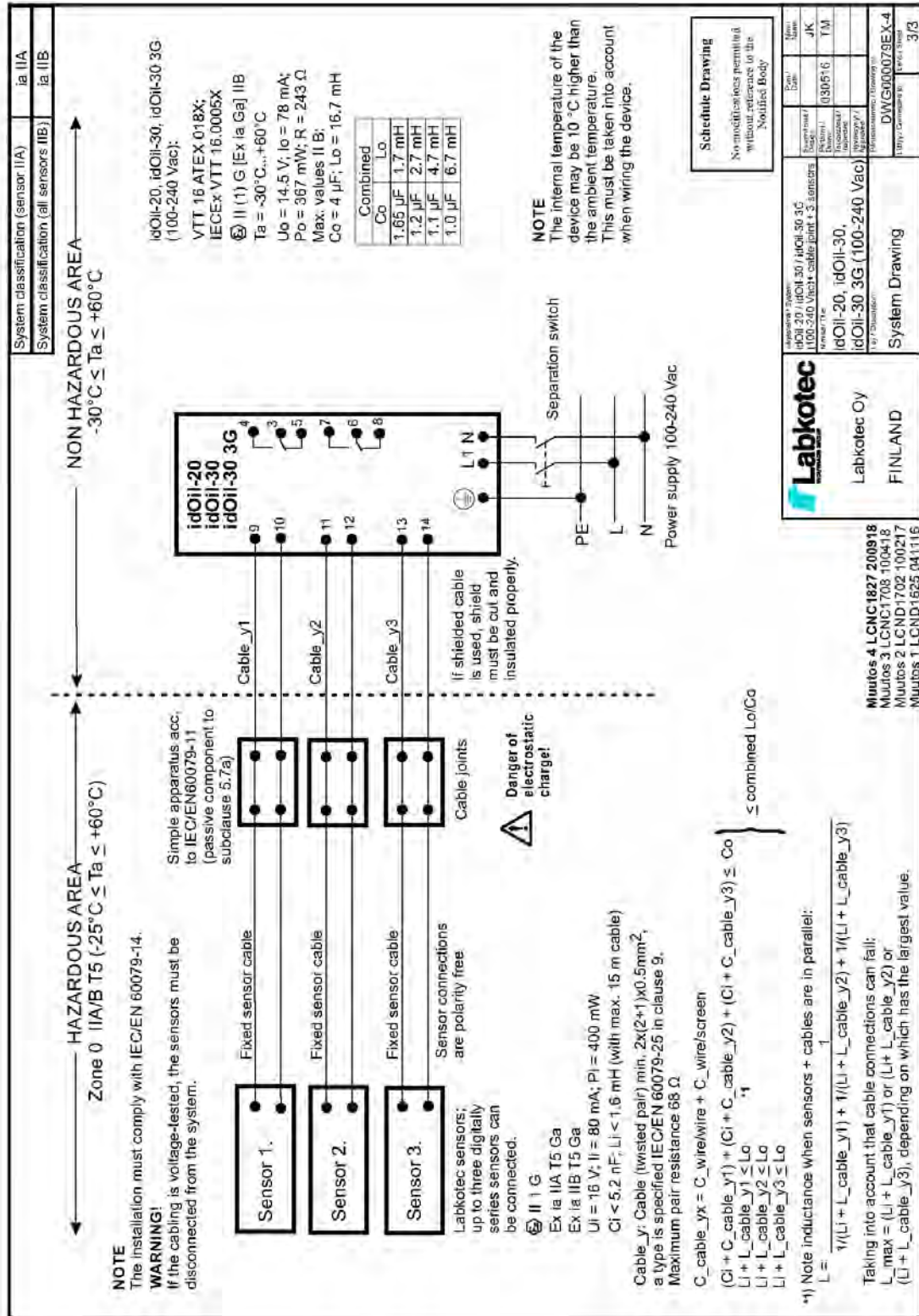

10.2. APPENDIX B EU Declaration of Conformity



EU DECLARATION OF CONFORMITY

We hereby declare that the product named below has been designed to comply with the relevant requirements of the referenced directives and standards.

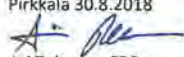
Product	idOil Control Units: idOil-20 idOil-30, idOil-30 3G, idOil-30 Battery, idOil-30 Battery 3G idOil-D30 idOil Solar
Manufacturer	Labkotec Oy Myllyhaantie 6 FI-33960 Pirkkala Finland
Directives	The product is in accordance with the following EU Directives: 2014/30/EU Electromagnetic Compatibility Directive (EMC) 2014/34/EU Equipment for Potentially Explosive Atmospheres Directive (ATEX) 2014/53/EU Radio Equipment Directive (RED) 2014/35/EU Low Voltage Directive (LVD) 2011/65/EU Restriction of Hazardous Substances Directive (RoHS)
Standards	The following standards were applied: EMC: EN 61000-6-2:2005/AC:2005 EN 61000-6-3:2007/A1:2011/AC:2012 EN 61000-3-2:2014 EN 61000-3-3:2013 ATEX: EN 60079-0:2012/A11:2013 EN 60079-11:2012 EN 60079-25:2010 EU-type examination certificate: VTT 16 ATEX 018X. Notified Body: Eurofins Expert Services Ltd, Notified Body number 0537. RED: EN 301 511 v12.5.1 EN 301 908-1 v11.1.1 EN 301 908-2 v11.1.2 EN 300 328 v2.1.1 LVD: EN 61010-1:2010 RoHS: EN 50581:2012 The product is CE-marked since 2018.
Signature	This declaration of conformity is issued under the sole responsibility of the manufacturer. Signed for and on behalf of Labkotec Oy. Pirkkala 30.8.2018  Ari Tolonen, CEO Labkotec Oy

Labkotec Oy | Myllyhaantie 6, FI-33960 Pirkkala, Finland | Tel. +358 29 006 260 | info@labkotec.fi DOC001718-EN



EU DECLARATION OF CONFORMITY

We hereby declare that the product named below has been designed to comply with the relevant requirements of the referenced directives and standards.

Product	Level sensor idOil-OIL, idOil-OIL-S
Manufacturer	Labkotec Oy Myllyhaantie 6 FI-33960 Pirkkala Finland
Directives	The product is in accordance with the following EU Directives: 2014/30/EU Electromagnetic Compatibility Directive (EMC) 2014/34/EU Equipment for Potentially Explosive Atmospheres Directive (ATEX) 2011/65/EU Restriction of Hazardous Substances Directive (RoHS)
Standards	The following standards were applied: EMC: EN 61000-6-2:2005/AC:2005 EN 61000-6-3:2007/A1:2011/AC:2012 ATEX: EN 60079-0:2012/A11:2013 EN 60079-11:2012 EU-type examination certificate: VTT 17 ATEX 004X. Notified Body: VTT Expert Services Ltd, Notified Body number 0537. RoHS: EN 50581:2012 The product is CE-marked since 2017.
Signature	This declaration of conformity is issued under the sole responsibility of the manufacturer. Signed for and on behalf of Labkotec Oy. Pirkkala 30.8.2018  Ari Tolonen, CEO Labkotec Oy



EU DECLARATION OF CONFORMITY

We hereby declare that the product named below has been designed to comply with the relevant requirements of the referenced directives and standards.

Product	Level sensor idOil-LIQ
Manufacturer	Labkotec Oy Myllyhaantie 6 FI-33960 Pirkkala Finland
Directives	The product is in accordance with the following EU Directives: 2014/30/EU Electromagnetic Compatibility Directive (EMC) 2014/34/EU Equipment for Potentially Explosive Atmospheres Directive (ATEX) 2011/65/EU Restriction of Hazardous Substances Directive (RoHS)
Standards	The following standards were applied: EMC: EN 61000-6-2:2005/AC:2005 EN 61000-6-3:2007/A1:2011/AC:2012 ATEX: EN 60079-0:2012/A11:2013 EN 60079-11:2012 EU-type examination certificate: VTT 17 ATEX 005X. Notified Body: VTT Expert Services Ltd, Notified Body number 0537. RoHS: EN 50581:2012 The product is CE-marked since 2017.
Signature	This declaration of conformity is issued under the sole responsibility of the manufacturer. Signed for and on behalf of Labkotec Oy. Pirkkala 30.8.2018  Ari Tolonen, CEO Labkotec Oy



EU DECLARATION OF CONFORMITY

We hereby declare that the product named below has been designed to comply with the relevant requirements of the referenced directives and standards.

Product	Level sensor idOil-SLU
Manufacturer	Labkotec Oy Myllyhaantie 6 FI-33960 Pirkkala Finland
Directives	The product is in accordance with the following EU Directives: 2014/30/EU Electromagnetic Compatibility Directive (EMC) 2014/34/EU Equipment for Potentially Explosive Atmospheres Directive (ATEX) 2011/65/EU Restriction of Hazardous Substances Directive (RoHS)
Standards	The following standards were applied: EMC: EN 61000-6-2:2005/AC:2005 EN 61000-6-3:2007/A1:2011/AC:2012 ATEX: EN 60079-0:2012/A11:2013 EN 60079-11:2012 EU-type examination certificate: VTT 17 ATEX 006X. Notified Body: VTT Expert Services Ltd, Notified Body number 0537. RoHS: EN 50581:2012 The product is CE-marked since 2017.
Signature	This declaration of conformity is issued under the sole responsibility of the manufacturer. Signed for and on behalf of Labkotec Oy. Pirkkala 30.8.2018  Ari Tolonen, CEO Labkotec Oy



EU DECLARATION OF CONFORMITY

We hereby declare that the product named below has been designed to comply with the relevant requirements of the referenced directives and standards.

Product(s)	LCJ1-1 cable connector for one sensor LCJ1-2 cable connector for two sensors LCJ1-3 cable connector for three sensors
Manufacturer	Labkotec Oy Myllyhaantie 6 FI-33960 Pirkkala Finland
Directives	The product is in accordance with the following EU Directives: 2014/34/EU Equipment for Potentially Explosive Atmospheres Directive (ATEX) 2011/65/EU Restriction of Hazardous Substances Directive (RoHS)
Standards	The following standards were applied: ATEX: EN 60079-0:2012/A11:2013 EN 60079-11:2012 The product is a simple apparatus according to EN 60079-11:2012 (Intrinsic Safety i). RoHS: EN 50581:2012 The product is CE-marked since 2018.
Signature	This declaration of conformity is issued under the sole responsibility of the manufacturer. Signed for and on behalf of Labkotec Oy.

Pirkkala 8.6.2018

A handwritten signature in blue ink, appearing to read 'Ari Tolonen', written over a horizontal line.

Ari Tolonen, CEO
Labkotec Oy